

CAPITAL COMMITTEE

June 13, 2013

MEETING AGENDA

11:00 a.m.

125 Worth Street,
Room 532
5th Floor Board Room

CALL TO ORDER

Emily A. Youssouf

- ADOPTION OF MINUTES April 11, 2013

Emily A. Youssouf

- ASSISTANT VICE PRESIDENT'S REPORT

Alfonso C. Pistone

ACTION ITEMS

- **Resolution**

Ann Sullivan, MD

Authorizing the President of the New York City Health and Hospitals Corporation (the "Corporation" or "Licensor") to execute a revocable license agreement with the American Cancer Society, Eastern Division, Inc. ("ACS" or the "Licensee"), for its continued use and occupancy of space to provide non-clinical patient support services on the campuses of Elmhurst Hospital and Queens Hospital Centers (the "Facilities").

Vendex: Documents are being completed by vendor and will be submitted to the Office of Legal Affairs prior to presentation before the full Board of Directors.

- **Resolution**

Denise Soares

Authorizing the President of the New York City Health and Hospitals Corporation (the "Corporation" or "Licensor") to execute a revocable license agreement with the American Academy McAllister Institute of Funeral Service (the "Licensee") for its use and occupancy of space to provide instruction in the techniques of mortuary science on the campus of Harlem Hospital Center (the "Facility").

Vendex: Pending. Certificate of No Change submitted to the Office of Legal Affairs.

- **Resolution**

Arthur Wagner

Authorizing the President of the New York City Health and Hospitals Corporation (the "Corporation") to modify the scope and budget for the existing Boiler Plant project at Coney Island Hospital (the "Facility") to add an additional \$2,935,845, increasing the total project budget to an amount not-to-exceed \$9.94 million.

- **Resolution**

Peter Lynch

Authorizing the President of the New York City Health and Hospitals Corporation (the "Corporation") to execute construction requirements contracts with six (6) firms: Gridspan Corporation; Vastech Contracting Corporation; Volmar Construction, Inc.; Sierra Mechanical Contracting, Inc.; Jemco Electrical Contractors, Inc.; and Charan Electrical Enterprises, Inc. (the

"Contractors"), to provide construction services on an as-needed basis at various facilities throughout the Corporation. Each individual contract shall be for a term of two (2) years, for an amount not to exceed \$6,000,000. The total authorized value of these contracts is \$36 Million.

Vendex: Approved for Volmar Construction, Inc. Documents for all other contractors have been submitted to the Office of Legal Affairs and are pending approval.

- **Resolution** **Peter Lynch**
Authorizing the President of the New York City Health and Hospitals Corporation (the "Corporation") to execute construction requirements contracts with four (4) firms: Par Plumbing Co., Inc.; Richard Plumbing and Heating Co., Inc.; Empire Control Abatement, Inc.; and New York Environmental Systems, Inc. (the "Contractors"), to provide construction services on an as-needed basis at various facilities throughout the Corporation. Each individual contract shall be for a term of two (2) years, for an amount not to exceed \$2,000,000. The total authorized value of these contracts is \$8 Million.

Vendex: Approved for all contractors.

- **Work Order – Economic Development Corporation** **Michael Buchholz**
Authorizing the President of the New York City Health and Hospitals Corporation (the "Corporation") to increase the New York City Economic Development Corporation's (NYCEDC) work order threshold by fourteen million, one hundred thirteen thousand, seven hundred sixty-seven dollars (\$14,113,767) to one hundred thirty-two million, four hundred fifty thousand, seven hundred fifty-six dollars (\$132,450,756) to provide project management services that will manage the architectural, engineering design services, pre-construction, construction, construction management services for the Construction of the New Skilled Nursing Facility (SNF) to be built in the parking lot of the former North General Hospital.

- **Work Order – Economic Development Corporation** **Michael Buchholz**
Authorizing the President of the New York City Health and Hospitals Corporation (the "Corporation") to decrease New York City Economic Development Corporation's (NYCEDC) work order threshold by four million, ninety-nine thousand, three hundred and sixty-seven dollars (-\$4,099,367) to one hundred twenty-four million, three hundred forty-one thousand, four hundred and twelve dollars (\$124,341,412) to continue providing project management services to manage the architectural, engineering design services, pre-construction, construction, construction management services for renovating the existing North General Hospital building into a new 201 bed Long Term Acute Care Hospital building (LTACH).

INFORMATION ITEMS

- **Henry J. Carter – Major Modernization – Status Report** **Robert Hughes**
- **Air Conditioning Readiness Report – Johnson Controls** **Stephen Terrano**
- **Presentation – HHC's Construction Program** **Alfonso Pistone**
- **Project Status Reports** **Alfonso Pistone**

Capital Committee Agenda

3

June 13, 2013

Central/North Brooklyn Health Network

Generations+/Northern Manhattan Health Network*

Queens Health Network*

* Network contains project(s) that require a delay report

OLD BUSINESS

NEW BUSINESS

ADJOURNMENT

CAPITAL COMMITTEE MEETING MINUTES

APRIL 11, 2013

MINUTES

Capital Committee

Meeting Date: April 11, 2013

Time: 11:00 A.M.

Location: Board Room

Board of Directors:

Members of the Capital Committee

Emily A. Youssouf, Chair
Josephine Bolus, RN
Alan D. Aviles, President
Michael A. Stocker, MD, Chairman of the Board

HHC Staff:

Jeremy Berman – Deputy Counsel, Legal Affairs
LaRay Brown – Senior Vice President, Corporate Planning and Community Health
Deborah Cates – Chief of Staff, Office of the Chairman
Manding Darboe – Assistant Director, Office of Facilities Development
Barbara Delorio – Senior Director, President’s Office
Martin Everette – Director, Affirmative Action/Equal Opportunity Employment
Rebecca Fischer – Associate Executive Director, Bellevue Hospital Center
Jonathan Goldstein – Senior Consultant, Corporate Planning
Anthony Gounaris – Senior Project Manager, Office of Facilities Development
Elizabeth Guzman – Chief Financial Officer, Metropolitan Hospital Center
Mendel Hagler – Executive Director, Gouverneur Healthcare Services
Juan Izquierdo – Associate Executive Director, Queens Hospital Center
Patricia Lockhart – Secretary to the Corporation, Office of the Chairman
Peter Lynch – Senior Director, Office of Facilities Development
Tamiru Mammo – Chief of Staff
Nini Mar – Director, Corporate Reimbursement
Antonio Martin – Executive Vice President
Hector Mazara – Senior Associate Director, Metropolitan Hospital Center
Dean Moskos – Director, Office of Facilities Development
Dean Pearce – Senior Director, Office of Facilities Development
Alfonso Pistone – Assistant Vice President, Office of Facilities Development
Michael Rawlings – Associate Director, Bellevue Hospital Center
Salvatore Russo – Senior Vice President, General Counsel, Legal Affairs
Thomas Scully – Senior Associate Director, Elmhurst Hospital Center
Denise Soares – Senior Vice President, Generations+/Northern Manhattan Health Network
Cyril Toussaint – Director, Office of Facilities Development
Ksenija Vukov-Drazevic – Senior Associate Director, Queens Hospital Center
Meryl Weinberg – Executive Director, Metropolitan Hospital Center

Roslyn Weinstein –Senior Assistant Vice President, President's Office
Manasses Williams – Assistant Vice President, Affirmative Action/Equal Opportunity Employment
Dion Wilson – Assistant Director, Office of Facilities Development
Elizabeth Youngbar – Assistant Director, Office of Facilities Development
Frank Zanghi – Supervising Confidential Examiner, Internal Audits

Other Attendees:

Vincent Barrett – Bureau of Fiscal Services, Fire Department of the City of New York
Skip Hodge – New York Power Authority (NYPA)
Elizabeth Norman – Office of Management and Budget (OMB)
Juso Omaechevarria – New York Power Authority (NYPA)
John Pasicznyk – Managing Director, Construction and Metro New York Operations, Dormitory Authority of the State of New York
Steve Rush – Assistant Commissioner, Fire Department of the City of New York
Rino Travato – New York Power Authority (NYPA)

CALL TO ORDER

The meeting was called to order by Emily A. Youssouf, Chairman of the Capital Committee, at 11:11 A.M.

ASSISTANT VICE PRESIDENT'S REPORT

Alfonso Pistone, Assistant Vice President, Office of Facilities Development, provided an overview of the meeting agenda. He informed members of the Committee that there would be three action items for consideration. The first two the Committee could consider combining, as they relate to items involving energy conservation measures and boiler replacements at Metropolitan Hospital Center and Elmhurst Hospital Center. The third action item is a pass through for the purchase of 119 ambulances on behalf of the Fire Department of the City of New York (FDNY).

He stated that other than two projects in delay at Bellevue Hospital Center and Coney Island Hospital, whose status has not changed since last reported, there are no project at other facilities in the reporting cycle that are in delay of six months or more.

Mr. Pistone advised that there would be two (2) information items on the agenda; a short update on the renewal of license agreements for multi-service centers with the Human Resources Administration (HRA), given by Jeremy Berman, Deputy Counsel, and a progress report on the major modernization project at Gouverneur Healthcare Services.

That concluded his report.

On motion by the Chair, which was duly seconded, the Committee combined the two first two (2) action items.

Mr. Pistone provided an overview of the first two items, relating to energy efficiency. He advised that the projects were being managed by the New York Power Authority (NYPA) which is currently managing the window replacement and boiler replacement projects at Coney Island Hospital. The projects are energy conservation and remediation projects which include no cost grants from PlaNYC and the City of New York of more than \$10 million; \$1.3 million from the American Recovery and Reinvestment Act (ARRA) (stimulus funds), \$5 million in City funds, and the balance in financing approved by the Finance Committee on April 9, 2013. Mr. Pistone thanked the Finance Department and the Finance Committee for supporting the projects, and the Department of Citywide Administrative Services (DCAS) for making stimulus and PlaNYC funding available.

Mr. Pistone explained that the two (2) projects emanated from City funded energy audits that concluded with a number of energy related recommendations to reduce energy consumption. HHC along with a number of other local healthcare systems opted into the Mayor's Carbon Reduction Challenge to reduce carbon emissions by 30%.

One of the largest contributors to energy consumption is the dated, inefficient, and soon to be outdated, combustion of number six (6) fossil fuels, which the City has mandated be phased out by 2015. An added benefit and incentive to replacement of the boilers is compliance with the elimination of number six (6) fuel combustion at these two (2) locations. This is an opportunity to conduct underground storage

tank replacement and remediation work to address open violations. Both projects have a calculated simple payback under 16 years, and both facilities boilers are original to the respective sites. In short, the boilers are in dire need of replacement.

Both projects represent the advancement of energy conservation measures with reasonable payback periods, both projects have undergone a value engineering study with colleagues at the Office of Management and Budget (OMB) and the costs represented in the resolution represent hard numbers. Both projects have been bid, and both have a significant contingency.

ACTION ITEMS

- **Authorizing the President of the New York City Health and Hospitals Corporation (the "Corporation") to execute a Customer Installation Commitment ("CIC") with the New York City Department of Citywide Administrative Services ("DCAS") and the New York Power Authority ("NYPA") for an amount not-to-exceed \$28,462,001 for the planning, pre-construction, design, construction, procurement, construction management and project management services necessary for the Comprehensive Energy Efficiency upgrade project (the "Project") at Elmhurst Hospital Center (the "Facility").**
- **Authorizing the President of the New York City Health and Hospitals Corporation (the "Corporation") to execute a Customer Installation Commitment ("CIC") between the New York City Department of Citywide Administrative Services ("DCAS"), and the New York Power Authority ("NYPA") for an amount not-to-exceed \$34,349,705 for the planning, pre-construction, design, construction, procurement, construction management and project management services necessary for the Comprehensive Energy Efficiency upgrade project (the "Project") at Metropolitan Hospital Center (the "Facility").**

Chris Constantino, Executive Director, Elmhurst Hospital Center, read the resolution into the record on behalf of Ann Sullivan, MD, Senior Vice President, Queens Health Network. Meryl Weinberg, Executive Director, Metropolitan Hospital Center, read the resolution into the record on behalf of Lynda Curtis, Senior Vice President, South Manhattan Health Network. Mr. Constantino and Ms. Weinberg were joined by Rino Trovato, Skip Hodge, and Juso Omaechevarria, New York Power Authority (NYPA).

Ms. Youssouf asked for an explanation of the financing structure used by NYPA. Mr. Omaechevarria advised that the financing was based on a commercial paper available rate, that rate would reset every January when it would be based on the previous twelve (12) months using a weighted average. He noted that the financing structure is not program specific to these projects it is the same used for their overall, approximately \$500 million, capital program. He said the current 2013 rate, for all customers throughout the five boroughs and statewide, is 0.86%.

Ms. Youssouf said she understood that there was an annual cap but asked about the ability to have fixed rate financing to prevent exposure to HHC. Mr. Omaechevarria advised that the interest rate is negotiated every three years and the structure is based on the previous year's rates but a not-to-exceed cap is placed at 5.9%.

Ms. Youssouf stated that HHC had requested a fixed rate agreement. Mr. Omaechevarria advised that NYPA was in discussion with HHC Finance and NYPA Finance to determine whether a fixed rate can or will be used. He explained that some discussion points are that fixed rate agreements don't have flexibility to pay-off loans in advance. Ms. Youssouf acknowledged the customary fixed rate lock-out of approximately 5-10 years, but added that it would not be likely that HHC would make pre-payments. She asked that if a fixed rate option be offered that she would like to ensure that it is absolutely in whatever contract is signed at present, and that we (HHC) have the right to switch without penalty to a fixed rate agreement. She asked that Legal Affairs and Mr. Pistone be sure that is the case.

Ms. Youssouf expressed excitement about the energy efficiency projects and asked which others were coming up. Antonio Martin, Executive Vice President, advised that there are potential projects for Cumberland Diagnostic and Treatment Center and Woodhull Medical and Mental Health Center being discussed.

There being no further questions or comments, the Committee Chair offered the matters for a Committee vote.

On motion by the Chair, the Committee approved the resolutions for the full Board's consideration.

- **Authorizing the President of the New York City Health and Hospitals Corporation (the "Corporation") to procure and outfit one hundred-nineteen (119) ambulances in Fiscal Year 2014 on behalf of the Fire Department of the City of New York ("FDNY"), through City-wide Requirements Contracts for a total amount not-to-exceed \$37.3 million.**

Dean Moskos, Director, Office of Facilities Development, read the resolution into the record. Mr. Moskos was joined by Steve Rush, Assistant Commissioner, and Vincent Barrett, Fire Department of the City of New York.

Ms. Youssouf stated that, as she understood, this arrangement was complete pass through. Mr. Moskos and Mr. Pistone agreed. Ms. Youssouf asked why the purchase is made in this manner and why the appropriation was not given directly to the FDNY. Mr. Rush explained that as part of the long standing relationship between the FDNY and HHC the FDNY runs Emergency Medical Services (EMS) on behalf of HHC, and HHC in return, due to the Medicaid reimbursement rate received for inpatient discharges (of which the depreciation of ambulances is built into) and therefore the money is passed back to HHC and back to the City as repayment to the Fire Department for its services. Mr. Moskos added that the arrangement is part of a Memorandum of Understanding from 1996.

Mrs. Bolus asked what happens to the old ambulances. Mr. Rush advised that ambulances are typically kept in frontline service for approximately five (5) to six (6) years, are then utilized as back-up ambulances for approximately eight (8) to ten (10) years, and then are finally sold at auction. Ms. Youssouf asked how the sale is handled. Mr. Rush said the sale is handled by DCAS and the money, he believes, goes into the general City fund. Ms. Youssouf asked for confirmation of where the money goes when the ambulances are sold.

INFORMATION ITEMS

- **License Agreements – Human Resources Administration – Multi-Service Centers**

Jeremy Berman, Deputy Counsel, Legal Affairs, advised that license agreements for two multi-service centers operated with the Human Resources Administration would commence a new annual term beginning July 1, 2013, at the current occupancy rate. The agreements were authorized by the Board of Directors for a period of five (5) years, but the City of New York issues occupancy agreements on a year by year basis. However, the last annual renewal involved a rate increase that had not been authorized by the prior Board of Directors approval and therefor the agreements were re-presented to the Board of Directors, and it was then requested that the agreements be brought before the Committee annually to advise of the new term and any possible changes.

- **Gouverneur Healthcare Services – Major Modernization – Status Report**

Mendel Hagler, Executive Director, Gouverneur Healthcare Services, provided the status report on the project. Mr. Hagler was joined by John Pasicznyk, Managing Director, Construction and Metro New York Operations, Dormitory Authority of the State of New York (DASNY).

Mr. Hagler advised that over the past month the facility received State Department of Health (SDOH) pre-occupancy inspections on floors four (4), five (5), six (6) and seven (7), DOH approved occupancy of the 4th floor, and Imaging and Ophthalmology services had been relocated to that space in late March. He noted that the SDOH had recently advised that occupancy of floors five (5), six (6), and seven (7) could commence pending written documentation. Decanting of floors ten (10) and eleven (11) would hopefully take place in the next week to ten (10) days. In conclusion he advised that the facility was working closely with DASNY to transition the first floor phase of the project.

Mr. Pasicznyk explained that distributed photos showed progress of construction as well as occupied floors. He then reviewed the project budget. Mr. Pasicznyk advised that, as previously reported, the DASNY managed budget for the project was \$247.4 million; including construction, soft costs, Furniture, Fixtures and Equipment (FF&E) and a project contingency of \$8.75 million – with the contingency still holding. He noted that there were still some portions of the project not approved for funding by the City Office of Management and Budget (OMB), primarily \$13 million for FF&E and a \$5 million portion of the contingency that was being held back, therefore not available for the Project at the moment. As of March the construction value of the project was \$142 million, 78% of the total construction budget, with about \$40 million worth of work remaining.

Mr. Pasicznyk reviewed Minority and Women Owned Business Enterprise (MWBE) statistics on the project; which has a 14% MWBE participation rate and a 8% WBE participation rate, for a combined 22% participation rate.

Overall, the project is 78% complete, as measured by construction in place as of March 31, 2013. Floors 2 and 3 are the next floors to be delivered, with the Temporary Certificate of Occupancy (TCO) expected by May 2013. Floors 8 and 9 TCO is expected by October 2013. The 10th and 11th floors will decant patients to floors 5, 6 and 7, which is expected to begin April 12, 2013. Floors 10 and 11 TCO is expected by November 2013. The intention is to deliver the 1st floor TCO by February 2014.

That concluded the status report.

- **Project Status Reports**

Central/North Brooklyn Health Network
Generations+/Northern Manhattan Health Network*
Queens Health Network*

* Network contains project(s) that require a delay report

As noted in the Assistant Vice President's report, there were no reports to be provided.

There being no further business, the meeting was adjourned at 11:34 A.M.

LICENSE AGREEMENT

AMERICAN CANCER SOCIETY

**ELMHURST HOSPITAL CENTER
QUEENS HOSPITAL CENTER**

RESOLUTION

Authorizing the President of the New York City Health and Hospitals Corporation (the "Corporation" or "Licensor") to execute a revocable license agreement with the American Cancer Society, Eastern Division, Inc. ("ACS" or the "Licensee"), for its continued use and occupancy of space to provide non-clinical patient support services on the campuses of Elmhurst Hospital and Queens Hospital Centers (the "Facilities").

WHEREAS, in June 2010, the Board of Directors authorized the President to enter into a license agreement with the Licensee which by its terms expires September 19, 2013; and

WHEREAS, the annual cancer incidence in the Borough of Queens is over 9,000 cases, and cancer is among the leading causes of death for adults aged 25 to 64 in nearly all Queens neighborhoods; and

WHEREAS, the Licensee will make its Patient Navigation Program available to patients and staff at the Facilities; and

WHEREAS, the goal of the Licensee's Patient Navigation Program is to provide access to quality educational materials, support service referrals, and other resources for the medically underserved cancer patient population and their caregivers; and

WHEREAS, the Licensee's program shall enhance the continuum of care and treatment provided by the Facilities to patients diagnosed with cancer.

NOW, THEREFORE, be it

RESOLVED, that the President of the New York City Health and Hospitals Corporation (the "Corporation" or "Licensor") be and hereby is authorized to execute a revocable license agreement with the American Cancer Society, Eastern Division, Inc. ("ACS" or the "Licensee"), for its continued use and occupancy of space to provide non-clinical patient support services on the campuses of Elmhurst Hospital and Queens Hospital Centers (the "Facilities").

The Licensee shall be granted the continued use of approximately 120 square feet of space in room A-520 of the Main Hospital building on the Queens Hospital Center campus and approximately 120 square feet of space in room 203 of the Hope Pavilion on the Elmhurst Hospital Center campus (the "Licensed Space"). In lieu of an occupancy fee, the Licensee shall provide patient support services at the Facilities. The Facilities shall provide electricity, maintenance, and housekeeping to the Licensed Space.

The Licensee shall indemnify and hold harmless the Corporation and the City of New York from any and all claims arising by virtue of its use of the Licensed Space and shall also provide appropriate insurance naming each as additional insured parties.

The license agreement shall not exceed three (3) years without further authorization by the Board of Directors of the Corporation and shall be revocable by either party on sixty (60) days written notice.

EXECUTIVE SUMMARY
LICENSE AGREEMENT
AMERICAN CANCER SOCIETY
QUEENS HEALTH NETWORK

The President seeks authorization from the Board of Directors of the New York City Health and Hospitals Corporation to execute a revocable license agreement with the American Cancer Society, Eastern Division, Inc. ("ACS"), for its continued use and occupancy of space to provide non-clinical patient support services at the campuses of Elmhurst Hospital and Queens Hospital Centers ("Elmhurst" and "Queens").

The annual cancer incidence in the Borough of Queens is over 9,000 cases, and cancer is among the leading causes of death for adults aged 25 to 64 in nearly all Queens neighborhoods.

Since September 2007, the American Cancer Society, Eastern Division, Inc. ("ACS"), and the Queens Health Network have made the ACS Patient Navigation Program services available to cancer patients and caregivers at Elmhurst and Queens. The program provides services to approximately 1,200 patients per year.

The goal of the ACS Patient Navigation Program is to provide access to quality patient educational materials, support service referrals, and other resources for newly diagnosed cancer patients and their caregivers. Specifically, the Patient Navigation Program will:

- Provide cancer patients and caregivers with high-quality cancer information across the cancer survivorship continuum;
- Refer patients and caregivers to appropriate community-based state, and national resources including, but not limited to, ACS programs and services, as needed;
- Facilitate assistance for those with cultural or language barriers by referring patients and caregivers to appropriate resources;
- Help establish access to information and referral for support and resources (subject to patient consent) as part of the "standard of care" in the delivery of cancer-related services to the cancer patient population.

To meet these objectives, ACS provides a trained ACS employee ("Navigator") on-site at Elmhurst and Queens. The Navigator spends approximately 60% of his/her time at Queens, and 40% at Elmhurst. The Navigator is available to assist patients and staff Monday through Friday, from 9:00 a.m. to 5:00 p.m.

ACS will have the continued use of approximately 120 square feet of space in room A-520 of the main hospital building on the Queens campus and approximately 120 square feet of space in room 203 of the Hope Pavilion on the Elmhurst campus. In lieu of an occupancy fee, ACS will provide patient support services at the facilities. The facilities will provide electricity, maintenance, and housekeeping to the licensed space.

Page Two – Executive Summary
American Cancer Society

ACS will indemnify and hold harmless the Corporation and the City of New York from any and all claims arising by virtue of its use of the licensed space and will also provide appropriate insurance naming each as additional insured parties.

The license agreement shall not exceed three (3) years without further authorization by the Board of Directors of the Corporation and shall be revocable by either party on sixty (60) days written notice.

Queens Hospital Center

American Cancer Society
Main Building, 5th Floor, Room A-520
120 square-feet

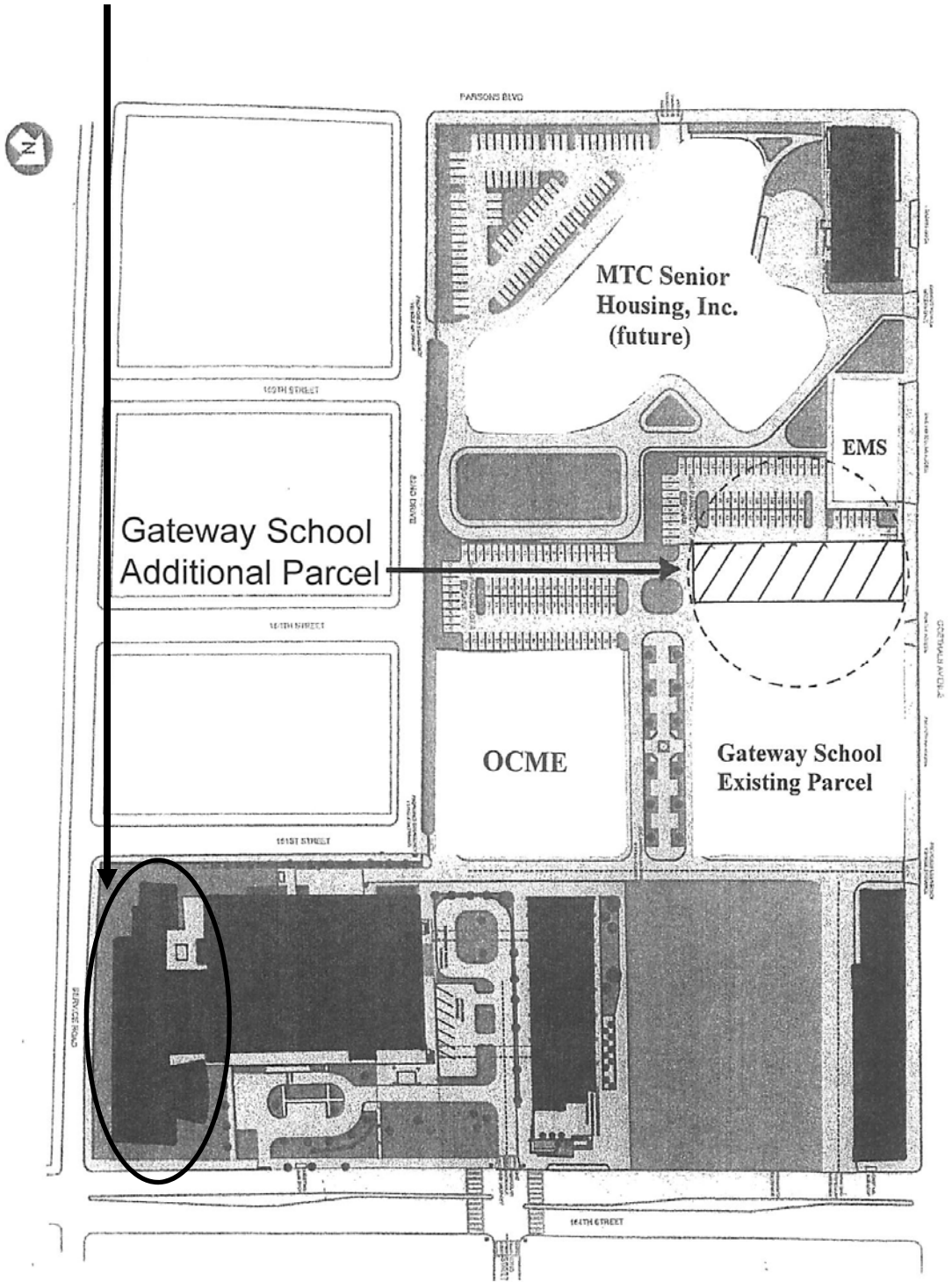

Elmhurst Hospital Center

American Cancer Society
Hope Pavilion, Room 203
120 square-feet

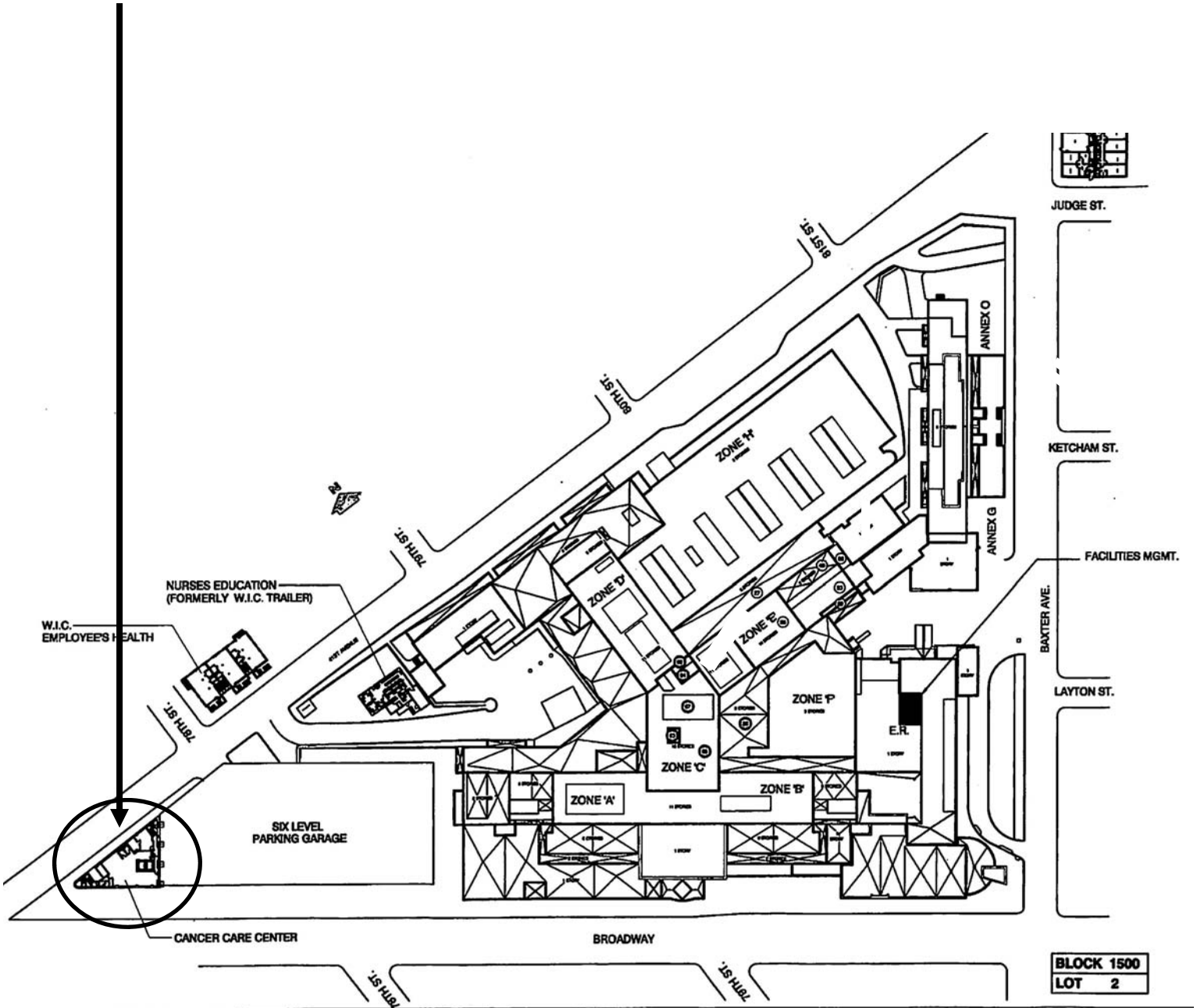

LICENSE AGREEMENT

**AMERICAN ACADEMY MCALLISTER
INSTITUTE OF FUNERAL SERVICE**

HARLEM HOSPITAL CENTER

RESOLUTION

Authorizing the President of the New York City Health and Hospitals Corporation (the "Corporation or "Licensor") to execute a revocable license agreement with the American Academy McAllister Institute of Funeral Service (the "Licensee") for its use and occupancy of space to provide instruction in the techniques of mortuary science on the campus of Harlem Hospital Center (the "Facility").

WHEREAS, the space the Licensee occupied in the basement of Bellevue Hospital Center suffered storm damage as a result of Sandy and is no longer suitable for the Licensee's use; and

WHEREAS, the Licensee provides practical instruction in the techniques of mortuary science including embalming, anatomical science, and the preparation of bodies for burial; and

WHEREAS, the Facility has appropriate space available on its campus to house the Licensee's educational program.

NOW, THEREFORE, be it

RESOLVED, that the President of the Corporation be and hereby is authorized to execute a revocable license agreement with the American Academy McAllister Institute of Funeral Service (the "Licensee"), for its use and occupancy of space to provide instruction in the techniques of mortuary science on the campus of Harlem Hospital Center (the "Facility").

The Licensee shall have the use and occupancy of approximately 650 square feet of space on the first floor of the Martin Luther King Building (the "Licensed Space"). The annual occupancy fee shall be \$7,779. The occupancy fee is the fair market value prorated to account for the Licensee's use of the space. The occupancy fee shall be escalated by 2.5% per year. The Facility shall provide all utilities, housekeeping, red bag waste disposal, security and maintenance during the term of the agreement.

The Licensee shall indemnify and hold harmless the Corporation and the City of New York for all personal injury or property damage claims arising from their activities with regard to the Licensed Space. In addition, the Licensee shall purchase general liability insurance within the limits prescribed by the Corporation naming the Corporation and the City of New York as additional insureds.

The term of this license agreement shall not exceed five (5) years without further approval of the Board of Directors of the Health and Hospitals Corporation, and shall be revocable by any of the parties on sixty (60) days prior written notice.

EXECUTIVE SUMMARY

LICENSE AGREEMENT

AMERICAN ACADEMY MCALLISTER INSTITUTE OF FUNERAL SERVICE

The President of the New York City Health and Hospitals Corporation seeks authorization from the Board of Directors to execute a revocable license agreement with the American Academy McAllister Institute of Funeral Service ("American Academy") for its use and occupancy of space to provide instruction in the techniques of mortuary science on the campus of Harlem Hospital Center ("Harlem").

American Academy previously occupied space in the basement of Bellevue Hospital Center. The basement suffered storm damage as a result of Sandy and is no longer suitable for their use. American Academy provides practical instruction in the techniques of mortuary science including embalming, anatomical science, and the preparation of bodies for burial. American Academy will hold classes year-round, instruction will be provided at Harlem four (4) days per week with each class lasting approximately four (4) hours.

American Academy will have the use of approximately 650 square feet of space on the first floor of the Martin Luther King Building (the "Licensed Space"). The annual occupancy fee shall be \$7,779. The occupancy fee is the fair market value prorated to account for American Academy's use of the space. The occupancy fee shall be escalated by 2.5% per year. The Facility shall provide all utilities, housekeeping, red bag waste disposal, security and maintenance during the term of the agreement.

American Academy shall indemnify and hold harmless the Corporation and the City of New York for all personal injury or property damage claims arising from their activities with regard to the licensed space. In addition, the Licensee shall purchase general liability insurance within the limits prescribed by the Corporation naming the Corporation and the City of New York as additional insureds.

The license agreement shall be revocable by any of the parties on sixty (60) days prior written notice. The term of this license agreement shall not exceed five (5) years without further approval of the Board of Directors of the Health and Hospitals Corporation.

SAVITT PARTNERS

May 30, 2013

Mr. Dion C. Wilson
Office of Facilities Development, Real Estate
New York City Health and Hospitals Corporation
346 Broadway, 12 West
New York, NY 10013

Re: Appraisal of Harlem Hospital Center Mortuary Sciences Laboratory – Ground Level in Hospital Space at 506 Malcolm X Boulevard, New York, NY 10037

Dear Dion:

Pursuant to your request, I visited the referenced property for the purpose of evaluating the rental rate of the existing mortuary sciences laboratory at the property. My evaluation is subject to the following:

- The unit is currently owned by New York City Health and Hospitals Corporation (HHC)
- The unit is located on the ground floor level of the Harlem Hospital Center
- The approximate square footage of the unit is 3,145sf as described
- This evaluation is for the purposes of determining the rental value to subtenants who use the space for services both ancillary and independent of normal hospital practices and services

Medical and laboratory spaces found independently in buildings surrounding the hospital center in the area around Harlem Hospital Center have rents ranging from approximately \$30 - \$45 per rentable square foot (rsf). The low end spectrum of the market would typically be in the older, un-renovated or minimally renovated buildings. They would also typically not be built for medical but for general office uses and not provide full building services. The high end would be in the larger and recently renovated buildings providing full service amenities such as concierge service with 7 day 24hour access. Medical offices in these buildings would be to code, be in good to excellent condition, with enhanced plumbing, electric and HVAC systems, and in many instances would also have substantial fixture improvements within the space (millwork, plumbing fixtures and cabinetry). These building spaces while used for medical offices would also be quite suitable for general office purposes but for the specific build-out needed for medical. Most medical offices, in general, unless built within the last 12 years, will not meet current ADA or other municipal code requirements, and unless nothing but a cosmetic face lift is contemplated, would require structural changes, permits, filings, etc. to meet code.

Units, however, located in this general vicinity that are situated in ground floor level portions of buildings would typically have rents up to 20% below the value of units as previously indicated (\$12-\$25 per rsf). Examples might be for filing, storage, therapeutic services associated with practices above, i.e. testing, therapy, etc. or a laboratory facility unable or not required to pay the higher rents but that need to be located, strategically, in a hospital corridor.

SAVITT PARTNERS

Rentals in this area have been, and we anticipate will remain, flat to positive as is the competing sales market. However, lease terms can be created to anticipate the changes in the industry as a whole, and as they relate to the specific medical group or tenant. Larger offices, those 2,500 square feet and larger, will remain the strongest.

The subject unit, used for mortuary services, represents a unique use and specific installation in terms thereof. The space provides and anticipates the opportunity for academic training and use for this subtenant in a required hospital environment. The unit consists of:

- A waiting area with 9 chairs
- 1 ADA accessible bathroom
- 1 viewing room
- 1 office
- 2 student labs with equipment and tables
- 12 refrigerated units for bodies
- 1 Utility room
- 1 Supply room
- 1 storage room
- 1 small locker room with a shower

Features

- Security cameras tied to the hospital's security system
- Concrete floors throughout
- Floor drains throughout
- Independent thermostats. Unclear if tied in to building system or independent system.
- Space appears to be OSHA compliant.

The space is built fully tiled, floor to ceiling, with drainage throughout. Due to its unique installation and function, the drainage systems typically divert waste collected via a specific system use to treat the waste before it enters the city's main system. Because of the chemicals used within and the nature of the services provided by the mortuary program, the AC system is also typically modified to have upgraded air exchange within the demised premises. The floor and walls are tiled or concrete so the room can be hosed down and/or be sterilized as necessary. The space, while part of the hospital mortuary services program, seems to be run independently although the space is not physically segregated from the rest of the building. The unit will not retrofit without a complete physical renovation.

Heat appears to be supplied by the building, while the air conditioning is provided by an enhanced central system as described above. The bathroom facilities appear to be to ADA code requirements. It can be assumed that the space, because of its location within the hospital, is fully compliant with the ADA and other government regulations.

The subject space is located on the ground floor level of the main building on the Harlem Hospital Center, part of the New York City Health and Hospitals Corporation. The space is accessed through the hospital's main entrance on Malcolm X Boulevard and the mortuary

SAVITT PARTNERS

services portion has an entrance off a ground floor lobby corridor. There is an additional entrance directly to the loading dock allowing access for ambulances and other vehicles to the space.

The unit is in good to very good condition and appears to function properly for its intended use. The space is landlocked on the ground floor level and, accordingly, is windowless. All light and ventilation in the space is provided mechanically.

Our evaluation takes into account the aforementioned assumptions as well as the analysis of the market and the location and condition of the subject premises. There are no market comps for its use. The type of practice currently being maintained within the premises is consistent with that found in most hospitals. It is not an attractive use for most locations but because of the use, location and specific build out components, it is appropriate for a hospital as a landlord or owner to accept this use.

Our evaluation places this unit at approximately \$15 per rsf because of location, with an added premium of approximately \$20 per rsf for the aforementioned upgraded build out requirements and specific nature of the use. The use would be difficult to find in a stand-alone setting. Further, the space benefits from the common area access and is rented, therefore, on a net basis. By example, renting a unit in a stand-alone setting would require a tenant to pay not only for the space they use but for corridor space, bathrooms, lobby and waiting areas, and for electric services, cleaning and supplies, etc. Accordingly, a premium of 30% would be appropriate to add into the rent total to compensate for the additional space and services provided but not being considered in the square foot measurement. The rent, therefore, should be the equivalent of \$45.50 per rsf for the property improved as stated with the common area access and other services provided.

The purpose of the evaluation is to determine the rental value of this space if used by a part time mortuary school for training purposes. We understand that only a portion of the space will be used by the school two days per week. The portion used will consist of 2 autopsy rooms and any ancillary space needed for the use of the autopsy rooms, for example the bathrooms, locker rooms, entrances and exits to the space etc. The two autopsy rooms are approximately 350sf, including the ancillary space, the mortuary school will occupy approximately 650sf-700sf. Given these assumptions, the annual rental value of the space can be calculated as follows:

$$\begin{aligned} & \$45.50 \text{ per sf} * 650\text{sf} = \$29,575 \text{ per year} \\ & \$29,575 \text{ per year} / 365 \text{ days} = \$81.03 \text{ per day} \\ & \$81.03 \text{ per day} * 96 \text{ days of use per year} = \mathbf{\$7,778.88 \text{ per year}} \end{aligned}$$

Note that the annual rental value will be less or more than this amount depending on the number of days per year the mortuary school uses the space. Escalations would typically begin after the first year and would be anywhere from 3-5% per annum in any rent scenarios & consistent with current market conditions. Since this is a not-for-profit entity, there would not be appropriate “tax stops” added. Electric is not sub metered and can be included as an additional rental item. Given that HVAC is included in the space, a rate of \$3.50 per rsf would be acceptable.

In the event I can be of any further assistance to you, please do not hesitate to call me.

SAVITT PARTNERS

Very Truly Yours,

A handwritten signature in black ink, appearing to read "Michael Dubin". The signature is fluid and cursive, with a prominent initial "M" and a long, sweeping tail.

Michael Dubin

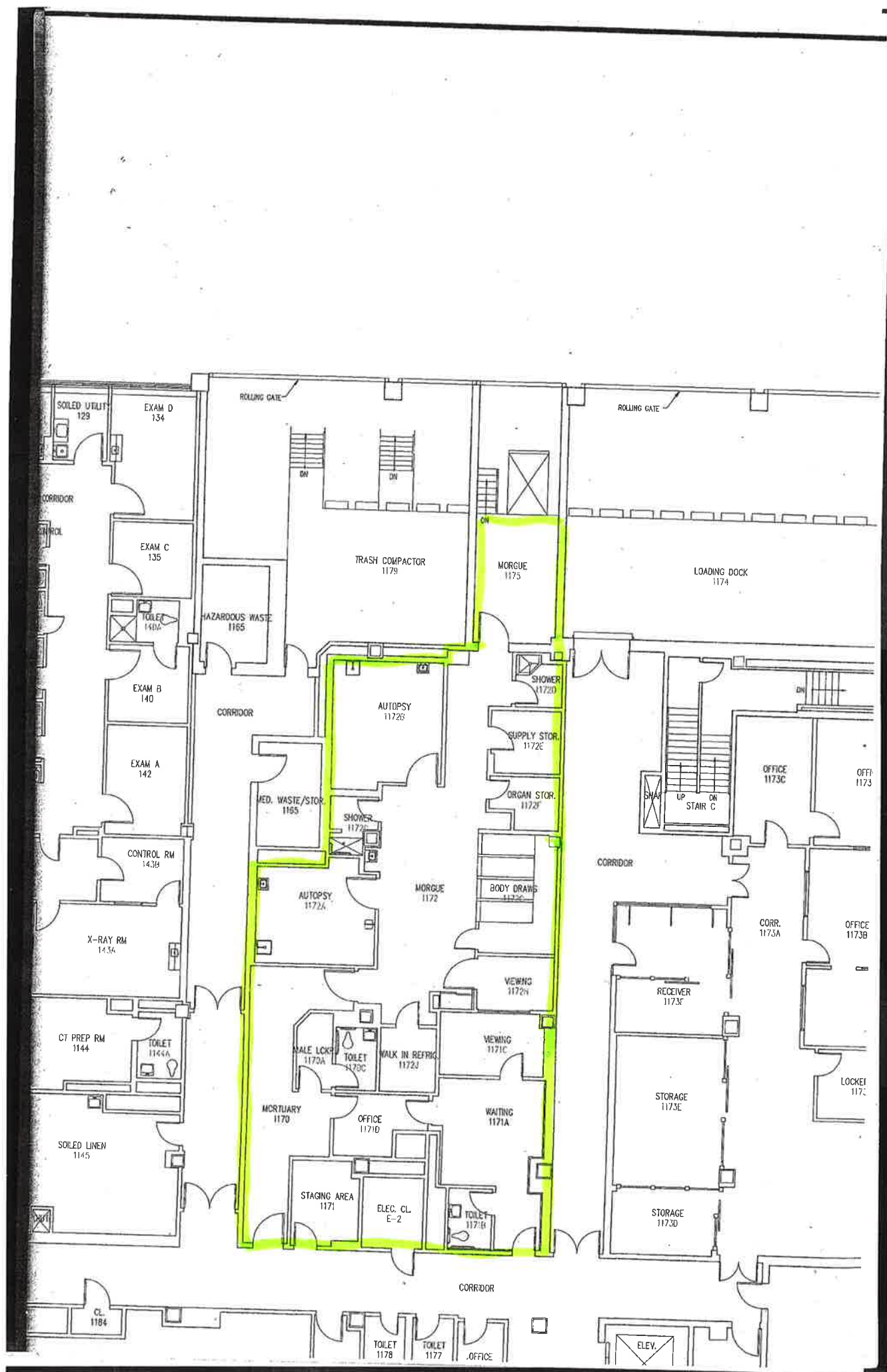

Harlem Hospital Center
Martin Luther King Pavilion, 1st Floor

American Academy McAllister Institute of Funeral Services
650 sf

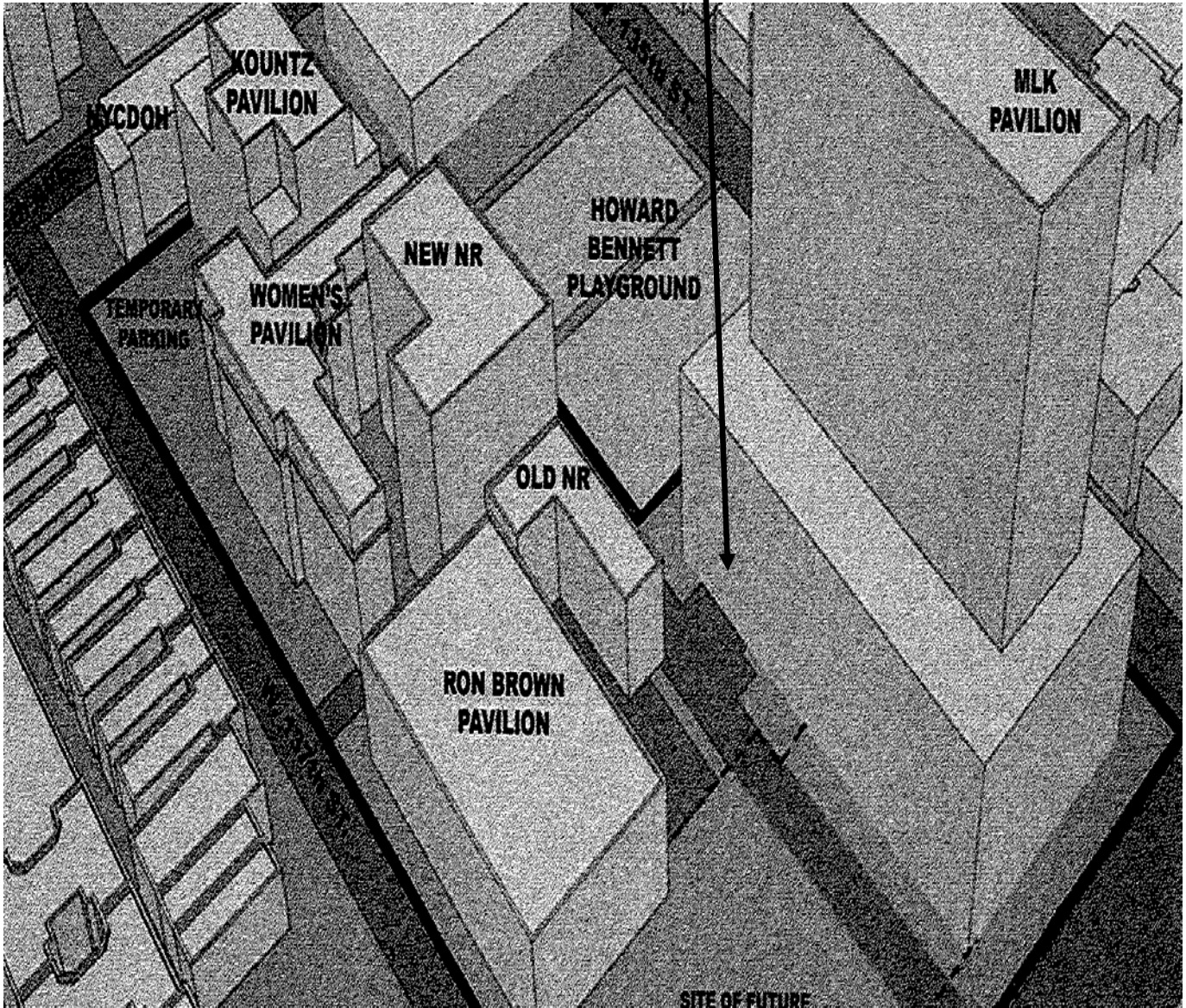

SCOPE & BUDGET MODIFICATION

BOILER PLANT PROJECT

CONEY ISLAND HOSPITAL

RESOLUTION

Authorizing the President of the New York City Health and Hospitals Corporation (the "Corporation") to modify the scope and budget for the existing Boiler Plant project at Coney Island Hospital (the "Facility") to add an additional \$2,935,845, increasing the total project budget to an amount not-to-exceed \$9.94 million.

WHEREAS, the Board of Directors approved a resolution on May 24, 2012, which authorized the New York Power Authority ("NYPA") to provide the planning, pre-construction, design services, construction, procurement, construction management and project management services necessary to replace the existing boiler plant at the Facility; and

WHEREAS, scope changes and other revisions to the project budget have been proposed to address structural damages incurred by the existing Facility Boiler House resulting from Hurricane Sandy, requiring boilers to be raised above the Federal Emergency Management Agency ("FEMA") designated 100-year flood line; and

WHEREAS, the additional work proposed to be performed will require an additional \$2,935,845 to the current project budget of \$6,997,980 to address these issues; and

WHEREAS, additional proposed work may be eligible for FEMA reimbursement as an element of broader remedial measures taken by the facility in response to hazard mitigation; and

WHEREAS, the overall management of the construction contract will be under the direction of the Facility's Senior Associate Director - Facilities and the Assistant Vice President – Facilities Development.

NOW THEREFORE, be it

RESOLVED, that the President of the New York City Health and Hospitals Corporation (the "Corporation") be and is hereby authorized to modify the scope and budget for the existing Boiler Plant project at Coney Island Hospital (the "Facility") to add an additional \$2,935,845, increasing the total project budget of an amount not-to-exceed \$9.94 million.

EXECUTIVE SUMMARY

CONEY ISLAND HOSPITAL NEW YORK POWER AUTHORITY (NYPA) BOILER PLANT REPLACEMENT

OVERVIEW:

Findings of the structural survey conducted on the Facility's Boiler House after Hurricane Sandy revealed voids in the soil under the existing floor slab. Design and engineering professionals familiar with hazard mitigation have recommended that the existing boiler house floor slab be demolished and replaced with new reinforced concrete floor slab to mitigate flood damage in future flood related events. The proposed new design changes include new structural supports over the new floor slab that will raise the new boilers and all other associated boiler auxiliary equipment above the FEMA designated 100-year flood line.

HHC will include this additional hazard mitigation work to FEMA with the expectation that it will be successful in receiving reimbursement for this claim. However, since consideration by FEMA is a future event, the result of which is uncertain, and HHC must proceed with this work immediately, HHC proceeds with this work 'at risk', in that if FEMA does not approve reimbursement, HHC will absorb the cost of remedial work without reimbursement.

ADDITIONAL SCOPE OF WORK:

- Demolish the existing floor slab in boiler house.
- Backfill and compact to grade the substrate under the existing floor slab.
- Excavate to existing boiler's supporting piers and install new beams across.
- Install new reinforced concrete floor slab for the boiler house.
- Install structural supports with grated platform on top, over the new floor slab to raise the new boilers above the FEMA 100-year flood line.
- Install structural supports to raise all other associated boiler auxiliary equipment above the FEMA 100-year flood line.
- Reconfigure all connections to the new boilers resulting from the raised platform.
- Provide 300kW emergency generator and associated switches to power the new boilers and auxiliary equipment.

ADDITIONAL COSTS: \$2,935,845.00

REVISED PROJECT COST: \$9,933,825.00

FINANCING: G.O. Bonds. HHC will seek reimbursement for change order work from FEMA.

SCHEDULE: HHC expects NYPA to complete this project by December 2013.

**CONEY ISLAND HOSPITAL
BOILER PLANT REPLACEMENT PROJECT
REVISED PROJECT COST**

| Item # | Item Description | Cost |
|---------------|---|----------------------------|
| 1 | Concrete Floor and Equipment Concrete Pads | \$ 311,200 |
| 2 | Structural Steel Work | \$ 214,463 |
| 3 | Submittals, Shop Drawings & Engineering Services | \$ 45,000 |
| 4 | Electrical Work and Fire Alarm System Modifications | \$ 494,400 |
| 5 | Furnish and Install a 208V Generator plus a 330 Gallon Tank | \$ 233,586 |
| 6 | Furnish and Install Fuel Oil Pumps | \$ 70,000 |
| 7 | Saw Cutting & Core Drilling | \$ 7,850 |
| 8 | Fire Stopping | \$ 7,375 |
| 9 | Generator Startup, Testing and Training | \$ 20,000 |
| 10 | Generator Building Department Permits | \$ 10,000 |
| 11 | Generator Contractor Closeouts | \$ 5,000 |
| 12 | Plumbing Work | \$ 45,560 |
| 13 | Mechanical Work | \$ 98,970 |
| 14 | Additional Rigging | \$ 19,600 |
| 15 | Overhead & Profit | \$ 316,601 |
| 16 | Sub-Total | \$ 1,899,605 |
| 17 | Construction Contingency | \$ 189,960 |
| 18 | Air Permitting Allowance | \$ 100,000 |
| 19 | Rental Boiler and Fuel Tank Allowance (6 months) | \$ 175,800 |
| | <i>Total Construction Cost</i> | <i>\$ 2,365,365</i> |
| 20 | Implementation Fees | \$ 283,844 |
| 21 | NYPA Fees | \$ 236,636 |
| 22 | Additional Independent Control Inspections | \$ 50,000 |
| | Total Cost for Additional Work | \$ 2,935,845 |
| | Previously Approved Amount | \$ 6,997,980 |
| | Revised Project Cost | \$ 9,933,825 |

RESOLUTION

Authorizing the President of the New York City Health and Hospitals Corporation (the "Corporation") to execute a contract with the New York Power Authority ("NYPA") for an amount not-to-exceed \$7,000,000 for the planning, pre-construction, design services, construction, procurement, construction management and project management services necessary to replace the existing boiler plant at Coney Island Hospital (the "Facility").

WHEREAS, in March 2005, the Corporation, the City University of New York (CUNY), the New York City Board of Education, and the City of New York, through the Department of Citywide Administrative Services (DCAS), executed an agreement with NYPA (the "Encore Agreement"), pursuant to which NYPA would enter into separate and specific sub-contracts with each Customer to implement comprehensive energy efficiency programs whose primary purpose would advance the cost-effective retrofitting or replacement of said Customer's existing heating and cooling technology through energy efficient measures relating to their usage of electricity and non-electric energy consumption; and

WHEREAS, the existing boiler plant has been in service since 1936, and consists of two (2) 256 Boiler Horse Power ("BHP") high-pressure, water-tube steam boilers, and one (1) 510 BHP high-pressure, water-tube steam boiler manufactured in 1954 and are increasingly difficult to maintain and operate effectively; and

WHEREAS, said boilers burn No. 6 grade fuel oil that will no longer be permitted for combustion on or before 2015 due to state and local legislation banning its continued use; and

WHEREAS, adoption of the Mayor's "PlaNYC" initiative to the boilers must be significantly renovated or replaced by 2015; and

WHEREAS, NYPA conservatively estimates that said boiler replacements will produce total annual energy cost savings of over \$1,200,000 and will reduce carbon emissions by approximately 11,100 tons, effectively eliminating the carbon equivalent emission of about 1,830 cars from operation; and

WHEREAS, the need to replace the existing boiler plant is funded through the Corporation's debt capacity and is recognized as requiring replacement as part of its Capital Plan.

NOW THEREFORE, be it

RESOLVED, that the President of the New York City Health and Hospitals Corporation (the "Corporation") be and is hereby authorized to execute an agreement with the New York Power Authority ("NYPA") in an amount not-to-exceed \$7,000,000 to include all phases of work, inclusive of the planning, pre-construction, design services, construction, procurement, construction management and project management services necessary to replace the two (2) existing boiler units at Coney Island Hospital (the "Facility").

EXECUTIVE SUMMARY

CONEY ISLAND HOSPITAL NEW YORK POWER AUTHORITY (NYPA) BOILER PLANT REPLACEMENT

OVERVIEW: Authorizing the President of the New York City Health and Hospitals Corporation (the "Corporation") to execute a contract with the New York Power Authority ("NYPA") for an amount not-to-exceed \$7,000,000. It includes the comprehensive planning, pre-construction, design services, construction, procurement, construction management and project management services necessary to replace the existing boiler plant at Coney Island Hospital (the "Facility"). This is a comprehensive, 'turnkey' project.

NEED: The existing boiler units currently provide service by burning heavier grade, number 6 fuel oil. The units have been in service for an extended period, and are operating inefficiently. Recent changes in environmental regulations will ban their combustion of No. 6 grade fuel oil by 2014/2015. Although recent changes to the environmental law permits a significant conversion extension from No. 6 to No. 2 grade fuel oil and/or natural gas to 2030, through retrofitting units to accept No. 4 fuel oil, the age and condition of the units make such an option impractical.

One unit has been in operation since 1936, and consists of two (2) 256 Boiler Horse Power (BHP) high-pressure, water-tube steam boilers, and one (1) 510 BHP high-pressure, water-tube steam boiler, manufactured in 1954. In addition to complying with recently enacted legislation regarding the combustion of No. 6 fuel oil, these replacements will increase efficiency and reliability, and will reduce energy costs and pollutants. The new units will permit, for the first time, the flexibility to operate on natural gas and No. 2 fuel oil. The facility will operate on a Firm Natural gas rate, which will optimize savings, and No. 2 fuel oil tanks will serve as service backups incase of emergency or service interruption. Together with two (2) other boiler replacement projects currently nearing design completion, this project was reviewed in a Value Engineering study conducted with the Mayor's Office of Management and Budget (OMB).

Finally, completion of this project satisfies recommendations advanced by OMB through its Assets Information Management System (AIMS) report.

SCOPE: Replacement of three (3) existing high-pressure boilers with three (3) high-pressure boilers, including but not limited to

- Replacement of existing de-aerator;
- Installation of new natural gas service;
- Conversion of existing No. 6 fuel oil tanks to No. 2 fuel oil tanks;
- Tie-in boiler controls to existing Building Management System (BMS) server; and,
- Replacement of existing steam traps in poor condition and a significant source of heat energy loss.

COSTS: Not-to-exceed \$7,000,000

FINANCING: HHC 2010 Series Bonds.

SCHEDULE: HHC expects NYPA to complete this project by February 2013.

REQUIREMENTS CONTRACTS

GENERAL CONTRACTING (GC)

GRIDSPAN CORPORATION

VASTECH CONTRACTING CORPORATION

HEATING, VENTILATION, AND AIR CONDITIONING (HVAC)

VOLMER CONSTRUCTION, INC.

SIERRA MECHANICAL CONTRACTING, INC.

ELECTRICAL(EL)

JEMCO ELECTRICAL CONTRACTORS, INC.

CHARAN ELECTRICAL ENTERPRISES, INC.

CORPORATE WIDE

RESOLUTION

Authorizing the President of the New York City Health and Hospitals Corporation (the "Corporation") to execute construction requirements contracts with six (6) firms: Gridspan Corporation; Vastech Contracting Corporation; Volmar Construction, Inc.; Sierra Mechanical Contracting, Inc.; Jemco Electrical Contractors, Inc.; and Charan Electrical Enterprises, Inc. (the "Contractors"), to provide construction services on an as-needed basis at various facilities throughout the Corporation. Each individual contract shall be for a term of two (2) years, for an amount not to exceed \$6,000,000. The total authorized value of these contracts is \$36 Million.

WHEREAS, the facilities of the Corporation may require professional construction services, such as, General Contracting (GC) services, Heating, Ventilation, and Air Conditioning (HVAC) services, and Electrical services; and

WHEREAS, the Corporation has determined that such needs can best be met by utilizing outside firms, on an as-needed basis, through a requirements contracts; and

WHEREAS, the Corporation's Operating Procedure No. 100-5 requires approval by the Board of Directors contracts of \$3,000,000 and above; and

WHEREAS, the Corporation published a request for bids for professional GC, HVAC, and electrical services, bids received were publicly opened on March 18, 2013, and March 21, 2013, and the Corporation determined that the Contractors are the lowest responsible bidders for these contracts; and

WHEREAS, the Contractors have met all, legal, business and technical requirements and are qualified to perform the services as required in the contract documents.

NOW, THEREFORE, be it

RESOLVED, the President of the New York City Health and Hospitals Corporation be and hereby is authorized to execute requirements contracts with six firms; Gridspan Corporation; Vastech Contracting Corporation; Volmar Construction, Inc.; Sierra Mechanical Contracting, Inc.; Jemco Electrical Contractors, Inc.; and Charan Electrical Enterprises, Inc., to provide construction services on an as-needed basis at various facilities throughout the Corporation. Each individual contract shall be for a term of two (2) years, for an amount not to exceed \$6,000,000. The total authorized to be spent under these contracts is \$36 Million.

EXECUTIVE SUMMARY

CONSTRUCTION SERVICES REQUIREMENTS CONTRACTS

GENERAL CONTRACTING (GC) – GRIDSPAN CORPORATION, AND VASTECH CONTRACTING CORPORATION

HEATING, VENTILATION, AND AIR CONDITIONING (HVAC) – VOLMAR CONSTRUCTION, INC., AND SIERRA MECHANICAL CONTRACTING, INC.

ELECTRICAL – JEMCO ELECTRICAL CONTRACTORS, INC., AND CHARAN ELECTRICAL ENTERPRISES, INC.

OVERVIEW: The Corporation seeks to execute six requirements contracts for a term of two years each, for individual amounts not-to-exceed \$6,000,000, to provide professional construction services on an as-needed basis at any HHC facility. The total authorized to be spent under these contracts is \$36 Million.

The method of requirements contract proposed starts with fixed prices for thousands of materials utilized in a typical construction project. The prices are derived from widely published construction reference works to which HHC subscribes that are updated at frequent intervals. The contractors awarded requirements contracts under the proposed resolution are later invited to submit proposals for particular projects. The requirements contractors submit proposals based upon acceptance of the fixed material prices and a multiplier based on such material costs to determine their labor cost proposals. For example, if a material to be installed is priced at \$10.00, and the contractor's labor multiplier to install that material is 1.0, the cost of that material and labor is \$10.00, inclusive of overhead and profit. If the multiplier is 1.2, then the cost of that material and labor is \$12.00, inclusive of overhead and profit.

This format has been used in previous HHC requirements contracts, and continues to be used by the New York City School Construction Authority, the Dormitory Authority of the State of New York State, the New York City Department of Design and Construction, the New York City Department of Environmental Protection, the United States Postal Services and others. The program was developed by the Department of Defense and has been in existence for more than twenty years.

NEED: The various facilities of the Corporation are likely to require GC, HVAC, and electrical services that vary in frequency, size and urgency, which cannot be timely and cost effectively completed through a dedicated design, bid and award process.

TERMS: The construction services will be provided via a work order system within a two (2) year period, each for an amount not to exceed \$6,000,000.

COSTS: Not-to-exceed \$6,000,000 over two years, for each of the six (6) contracts for a total of \$36 Million.

FINANCING: Requirements contracts provide a pre-qualified approved mechanism for Networks to access construction services. Networks establish funding sources such as capital funds from bond proceeds, grants or expense (Other Than Personnel Services - OTPS) funds.

Page Two – Executive Summary
Construction Services Requirements Contracts

SCHEDULE: Upon contract execution these contracts shall be in effect for two years or until funds are exhausted.

CONTRACT FACT SHEET
REQUIREMENTS CONTRACTS
GENERAL CONTRACTING (GC)
GRIDSPAN CORPORATION

CONTRACT SCOPE: General Contracting Services

CONTRACT DURATION: Two (2) years

CONTRACT AMOUNT: \$6,000,000

ADVERTISING PERIOD: Advertised in City Record 2/26/13 – 3/18/13.

BIDS RECEIVED: 9 bid proposals received for consideration. Gridspan was recommended as lowest responsive bidder.

HHC EXPERIENCE: Renovation of Behavioral Health Clinic, Kings County Hospital Center, completed 2011.

VENDEX: Pending. Documents have been submitted to the Office of Legal Affairs.

EEO: Pending.

CONTRACT FACT SHEET
REQUIREMENTS CONTRACTS
GENERAL CONTRACTING (GC)

VASTECH CONTRACTING CORPORATION

CONTRACT SCOPE: General Contracting Services

CONTRACT DURATION: Two (2) years

CONTRACT AMOUNT: \$6,000,000

ADVERTISING PERIOD: Advertised in City Record 2/26/13 – 3/21/2013.

BIDS RECEIVED: 10 bid proposals received for consideration. Vastech was recommended as lowest responsive bidder.

HHC EXPERIENCE: Requirements Contracts: Various Facilities. Completed in 2009, and 2012. Renovation of Dental Clinic at East New York Diagnostic and Treatment Center, Kings County Hospital Center, completed 2010.

VENDEX: Pending. Documents have been submitted to the Office of Legal Affairs.

EEO: Pending.

CONTRACT FACT SHEET

REQUIREMENTS CONTRACTS

HEATING, VENTILATION, AND AIR CONDITIONING (HVAC)

VOLMAR CONSTRUCTION, INC.

CONTRACT SCOPE: Heating, Ventilation, and Air Conditioning (HVAC) Services

CONTRACT DURATION: Two years

CONTRACT AMOUNT: \$6,000,000

ADVERTISING PERIOD: Advertised in City Record 2/26/13 – 3/18/13.

BIDS RECEIVED: 10 bid proposals received for consideration. Volmar Construction, Inc. was recommended as lowest responsive bidder.

HHC EXPERIENCE: Requirements Contract: Various Facilities. Completed in 2013.

VENDEX: Approved.

EEO: Approved.

Office of Legal Affairs

MEMORANDUM

To: Emmanuel O. Obadina
Office of Facilities Development

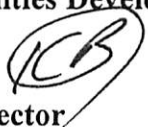
From: Karen Rosen 
Assistant Director

Date: May 23, 2013

Subject: VENDEX Approval

For your information, on May 23, 2013 VENDEX approval was granted by the Office of Legal Affairs for the following company:

Volmar Construction, Inc.

cc: Norman M. Dion, Esq.

CONTRACT FACT SHEET

REQUIREMENTS CONTRACTS

HEATING, VENTILATION, AND AIR CONDITIONING (HVAC)

SIERRA MECHANICAL CONTRACTING, INC.

CONTRACT SCOPE: Heating, Ventilation, and Air Conditioning (HVAC) Services

CONTRACT DURATION: Two years

CONTRACT AMOUNT: \$6,000,000

ADVERTISING PERIOD: Advertised in City Record 2/26/13 – 3/21/2013.

BIDS RECEIVED: 9 bid proposals received for consideration. Sierra Mechanical Contracting was recommended as lowest responsive bidder.

HHC EXPERIENCE: None.

VENDEX: Pending. Documents have been submitted to the Office of Legal Affairs.

EEO: Approved.

CONTRACT FACT SHEET
REQUIREMENTS CONTRACTS
ELECTRICAL (EL) SERVICES

JEMCO ELECTRICAL CONTRACTORS, INC.

CONTRACT SCOPE: Electrical Services

CONTRACT DURATION: Two years

CONTRACT AMOUNT: \$6,000,000

ADVERTISING PERIOD: Advertised in City Record 2/26/13 – 3/18/13.

BIDS RECEIVED: 7 bid proposals received for consideration. Jemco Electrical Contracting was recommended as lowest responsive bidder.

HHC EXPERIENCE: Requirements Contract: Various Facilities. Completed in 2013.

VENDEX: Pending. Documents have been submitted to the Office of Legal Affairs.

EEO: Pending.

CONTRACT FACT SHEET
REQUIREMENTS CONTRACTS
ELECTRICAL (EL) SERVICES

CHARAN ELECTRICAL ENTERPRISES, INC.

CONTRACT SCOPE: Electrical Services

CONTRACT DURATION: Two years

CONTRACT AMOUNT: \$6,000,000

ADVERTISING PERIOD: Advertised in City Record 2/26/13 – 3/21/2013.

BIDS RECEIVED: 6 bid proposals received for consideration. Charan Electrical Enterprises, Inc. was recommended as lowest responsive bidder.

HHC EXPERIENCE: None.

VENDEX: Pending. Documents have been submitted to the Office of Legal Affairs.

EEO: Pending.

REQUIREMENTS CONTRACTS

HAZARDOUS MATERIALS (HAZMAT)
EMPIRE CONTROL ABATEMENT, INC.
NEW YORK ENVIRONMENTAL

PLUMBING (PL)
PAR PLUMBING
RICHARDS PLUMBING AND HEATING

CORPORATE WIDE

RESOLUTION

Authorizing the President of the New York City Health and Hospitals Corporation (the "Corporation") to execute construction requirements contracts with four (4) firms: Par Plumbing; Richard Plumbing and Heating; Empire Control Abatement, Inc.; and New York Environmental Systems, Inc. (the "Contractors"), to provide construction services on an as-needed basis at various facilities throughout the Corporation. Each individual contract shall be for a term of two (2) years, for an amount not to exceed \$2,000,000. The total authorized value of these contracts is \$8 Million.

WHEREAS, the facilities of the Corporation may require professional construction services, such as, Hazardous Material (HazMat) services, and Plumbing services; and

WHEREAS, the Corporation has determined that such needs can best be met by utilizing outside firms, on an as-needed basis, through a requirements contracts; and

WHEREAS, the Corporation's Operating Procedure No. 100-5 requires approval by the Board of Directors contracts of \$3,000,000 and above; and

WHEREAS, the Corporation published a request for bids for professional HazMat, and plumbing services, bids received were publicly opened on March 18, 2013, and March 21, 2013, and the Corporation determined that the Contractors are the lowest responsible bidders for these contracts; and

WHEREAS, the Contractors have met all, legal, business and technical requirements and are qualified to perform the services as required in the contract documents.

NOW, THEREFORE, be it

RESOLVED, the President of the New York City Health and Hospitals Corporation be and hereby is authorized to execute requirements contracts with four firms; Par Plumbing; Richard Plumbing and Heating; Empire Control Abatement, Inc.; and New York Environmental, to provide construction services on an as-needed basis at various facilities throughout the Corporation. Each individual contract shall be for a term of two (2) years, for an amount not to exceed \$2,000,000. The total authorized to be spent under these contracts is \$8 Million.

EXECUTIVE SUMMARY

CONSTRUCTION SERVICES REQUIREMENTS CONTRACTS

PLUMBING (PL) SERVICES – PAR PLUMBING CO., INC., & RICHARDS PLUMBING AND HEATING CO., INC.

HAZARDOUS MATERIALS (HazMat) SERVICES - EMPIRE CONTROL ABATEMENT, INC., AND NEW YORK ENVIRONMENTAL SYSTEMS, INC.

OVERVIEW: The Corporation seeks to execute four requirements contracts for a term of two years each, for individual amounts not-to-exceed \$2,000,000, to provide professional construction services on an as-needed basis at any HHC facility. The total authorized to be spent under these contracts is \$8 Million.

The method of requirements contract proposed starts with fixed prices for thousands of materials utilized in a typical construction project. The prices are derived from widely published construction reference works to which HHC subscribes that are updated at frequent intervals. The contractors awarded requirements contracts under the proposed resolution are later invited to submit proposals for particular projects. The requirements contractors submit proposals based upon acceptance of the fixed material prices and a multiplier based on such material costs to determine their labor cost proposals. For example, if a material to be installed is priced at \$10.00, and the contractor's labor multiplier to install that material is 1.0, the cost of that material and labor is \$10.00, inclusive of overhead and profit. If the multiplier is 1.2, then the cost of that material and labor is \$12.00, inclusive of overhead and profit.

This format has been used in previous HHC requirements contracts, and continues to be used by the New York City School Construction Authority, the Dormitory Authority of the State of New York State, the New York City Department of Design and Construction, the New York City Department of Environmental Protection, the United States Postal Services and others. The program was developed by the Department of Defense and has been in existence for more than twenty years.

NEED: The various facilities of the Corporation are likely to require HazMat and plumbing services that vary in frequency, size and urgency, which cannot be timely and cost effectively completed through a dedicated design, bid and award process.

TERMS: The construction services will be provided via a work order system within a two (2) year period, each for an amount not to exceed \$2,000,000.

COSTS: Not-to-exceed \$2,000,000 over two years, for each of the four (4) contracts for a total of \$8 Million.

FINANCING: Requirements contracts provide a pre-qualified approved mechanism for Networks to access construction services. Networks establish funding sources such as capital funds from bond proceeds, grants or expense (Other Than Personnel Services - OTPS) funds.

SCHEDULE: Upon contract execution these contracts shall be in effect for two years or until funds are exhausted.

CONTRACT FACT SHEET
REQUIREMENTS CONTRACTS
PLUMBING (PL) SERVICES
PAR PLUMBING CO., INC.

CONTRACT SCOPE: Plumbing Services

CONTRACT DURATION: Two (2) years

CONTRACT AMOUNT: \$2,000,000

ADVERTISING PERIOD: Advertised in City Record from 2/26/13 through 3/18/13.

BIDS RECEIVED: 4 bid proposals received for consideration. Par Plumbing Co., Inc. recommended as lowest responsive bidder.

HHC EXPERIENCE: None.

VENDEX: Approved.

EEO: Approved.

Office of Legal Affairs

MEMORANDUM

To: Emmanuel O. Obadina
Office of Facilities Development

From: Karen Rosen 
Assistant Director

Date: May 22, 2013

Subject: VENDEX Approval

For your information, on May 22, 2013 VENDEX approval was granted by the Office of Legal Affairs for the following company:

Par Plumbing Co, Inc.

cc: Norman M. Dion, Esq.

CONTRACT FACT SHEET
REQUIREMENTS CONTRACTS
PLUMBING (PL) SERVICES

RICHARDS PLUMBING AND HEATING CO., INC.

CONTRACT SCOPE: Plumbing Services

CONTRACT DURATION: Two (2) years

CONTRACT AMOUNT: \$2,000,000

ADVERTISING PERIOD: Advertised in City Record from 2/26/13 through 3/21/13.

BIDS RECEIVED: 4 bid proposals received for consideration. Richards Plumbing and Heating Co., Inc. was recommended as lowest responsive bidder.

HHC EXPERIENCE: Requirements Contract: Various Facilities. Completed in 2011.

VENDEX: Approved.

EEO: Approved.

Office of Legal Affairs

MEMORANDUM

To: Clifton S. McLaughlin
Office of Facilities Development

From: Karen Rosen 
Assistant Director

Date: March 28, 2013

Subject: VENDEX Approval

For your information, on March 28, 2013 approval was granted by the Office of Legal Affairs for the following company:

Richards Plumbing and Heating Co., Inc.

cc: Norman M. Dion, Esq.

CONTRACT FACT SHEET

REQUIREMENTS CONTRACTS

HAZARDOUS MATERIALS (HazMat) SERVICES

NEW YORK ENVIRONMENTAL SYSTEMS, INC.

CONTRACT SCOPE: Hazardous Materials (HazMat) Services

CONTRACT DURATION: Two years

CONTRACT AMOUNT: \$2,000,000

ADVERTISING PERIOD: Advertised in City Record 2/26/13 – 3/18/13.

BIDS RECEIVED: 3 bid proposals received for consideration. NY Environmental Systems, Inc. was recommended as lowest responsive bidder.

HHC EXPERIENCE: None.

VENDEX: Approved.

EEO: Pending.

Office of Legal Affairs

MEMORANDUM

To: Clifton S. McLaughlin
Office of Facilities Development

From: Karen Rosen 
Assistant Director

Date: May 24, 2013

Subject: VENDEX Approval

For your information, on May 24, 2013 approval was granted by the Office of Legal Affairs for the following company:

New York Environmental Systems, Inc.

cc: Norman M. Dion, Esq.

CONTRACT FACT SHEET

REQUIREMENTS CONTRACTS

HAZARDOUS MATERIALS (HazMat) SERVICES

EMPIRE CONTROL ABATEMENT INC.

CONTRACT SCOPE: Hazardous Materials (HazMat) Services

CONTRACT DURATION: Two years

CONTRACT AMOUNT: \$2,000,000

ADVERTISING PERIOD: Advertised in City Record 2/26/13 – 3/21/13.

BIDS RECEIVED: 2 bid proposals received for consideration. Empire Control Abatement, Inc. was recommended as lowest responsive bidder.

HHC EXPERIENCE: Requirements Contracts: Various Facilities. Completed in 2010 and 2012.

VENDEX: Approved.

EEO: Pending.

Office of Legal Affairs

MEMORANDUM

To: Clifton S. McLaughlin
Office of Facilities Development

From: Karen Rosen 
Assistant Director

Date: May 23, 2013

Subject: VENDEX Approval

For your information, on May 23, 2013 approval was granted by the Office of Legal Affairs for the following company:

Empire Control Abatement, Inc

cc: Norman M. Dion, Esq.

WORK ORDER

ECONOMIC DEVELOPMENT CORPORATION

**HENRY J. CARTER
SKILLED NURSING FACILITY**

**NEW YORK CITY HEALTH & HOSPITALS CORPORATION
CAPITAL COMMITTEE**

**NEW YORK CITY ECONOMIC
DEVELOPMENT CORPORATION
WORK ORDER APPROVAL**

Date: June 13, 2013

In accordance with a Memorandum of Understanding by and between HHC and the New York City Economic Development Corporation (NYCEDC), the President of HHC respectfully submits for approval by the Capital Committee, the following Work Order to be issued to NYCEDC:

Facility: North General Hospital, also known as "Goldwater North"

Title: Construction of New Goldwater North Skilled Nursing Facility (SNF)

Scope: Serving as managing agent, EDC shall cause to be provided all architectural, engineering design services, pre-construction, construction, construction management and project management services necessary for the Construction of a New Skilled Nursing Facility in the Parking Lot of the former North General Hospital building.

Need: Construction of a new SNF facility at this site meets three (3) important strategic needs. 1) Achieves right sizing of HHC services through use of a New York State HEAL 19 grant; 2) Implements HHCs cost containment initiatives identified through the Road Ahead study which reduces the number of certified Coler-Goldwater SNF beds to 979, 164 of which will be located in the new building; 3) Recognizes a cost effective opportunity to build a new LEED certified facility and avoid extensive renovation costs necessary to renovating the existing Goldwater campus.

Estimate of Cost:

| | <i>Previously Approved 2/2012</i> | <i>Proposed Authorization Increase</i> | <i>New Authorization Level</i> | <i>Budget</i> |
|---------------------------------------|---------------------------------------|--|------------------------------------|----------------------|
| <i>Planning & Design Services</i> | 9,305,327 | 2,046,734 | 11,352,061 | 11,352,061 |
| <i>Construction</i> | 74,090,195 | 6,361,561 | 80,451,756 | 80,451,756 |
| <i>Construction Management</i> | 19,804,946 | 10,722,639 | 30,527,585 | 30,527,585 |
| <i>Other Costs</i> | 4,800,390 | (3,262,975) | 1,537,415 | 1,537,415 |
| <i>EDC Fee</i> | 2,344,526 | | 2,344,526 | 2,344,526 |
| <i>Contingency</i> | 7,991,605 | (4,379,692) | 3,611,913 | 3,611,913 |
| <i>Fixed Equipment</i> | 0 | | 0 | 930,589 |
| <i>Moveable Equipment</i> | 0 | | 0 | 3,852,059 |
| <i>Telecom Equipment</i> | 0 | | 0 | 2,569,489 |
| Total Project Cost | \$118,336,989 | \$11,488,267 | \$129,825,256 | \$137,177,393 |

| | | | | |
|--|----------------------|---------------------|----------------------|----------------------|
| <i>Additional Closing Costs to No. Gen'l</i> | 0 | 0 | 0 | 120,000 |
| <i>Planning & Design Services</i> | 0 | 0 | 0 | 69,967 |
| <i>VE Services (HEAL 19)</i> | 0 | 0 | 0 | 213,893 |
| <i>CON Additional Processing Fee</i> | 0 | 0 | 0 | 860,467 |
| <i>Goldwater Decommissioning</i> | 0 | 2,625,500 | 2,625,500 | 2,625,500 |
| Total Project Cost w/CON Fee | \$118,336,989 | \$14,113,767 | \$132,450,756 | \$141,067,220 |

Funding:

| | | | | |
|-------------------------------------|----------------------|---------------------|----------------------|----------------------|
| <i>HEAL NY Phase 19 *</i> | 8,575,220 | 0 | 8,575,220 | 9,839,547 |
| <i>NYC General Obligation Bonds</i> | 109,761,769 | 14,113,767 | 123,875,536 | 131,227,673 |
| Total | \$118,336,989 | \$14,113,767 | \$132,450,756 | \$141,067,220 |

End Date: November 2013

CON: Full Review

CON: Full Review

Filed: Original filed October 7, 2010

Filed: Original filed October 7, 2010

Approval: Original Approved December 2, 2011

Amended approval anticipated February 2012

**EXECUTIVE SUMMARY
MAJOR MODERNIZATION PROJECT
GOLDWATER NORTH SKILLED NURSING FACILITY
BY NEW YORK CITY ECONOMIC DEVELOPMENT CORPORATION**

- OVERVIEW:** The President seeks authorization to increase the New York City Economic Development Corporation's (NYCEDC) work order threshold by fourteen million, one hundred thirteen thousand, seven hundred sixty-seven dollars (\$14,113,767) to one hundred thirty-two million, four hundred fifty thousand, seven hundred fifty-six dollars (\$132,450,756) to provide project management services that will manage the architectural, engineering design services, pre-construction, construction, construction management services for the Construction of the New Skilled Nursing Facility (SNF) to be built in the parking lot of the former North General Hospital.
- NEED:** Construction of a new SNF facility at this site meets three (3) important strategic needs. 1) Achieves right sizing of HHC services through use of a New York State HEAL 19 grant; 2) Implements HHC's costs containment initiatives identified through the Road Ahead study which reduces the number of Coler-Goldwater SNF beds to 979, 164 of which will be located in the new building; 3) Recognizes a cost effective opportunity to build a new LEED certified facility and avoid extensive renovation costs necessary to renovating the existing Goldwater campus. It is more advantageous to construct a new building rather than renovate and upgrade a significantly older and occupied campus at Goldwater (constructed circa 1939) to meet new code requirements. The bed count on the facility has been reduced from 276 beds to 164 beds.
- SCOPE:** NYCEDC will serve as managing agent, and will cause to provide all architectural and engineering design services, pre-construction, construction, construction management and project management services necessary for the Construction of the New Skilled Nursing Facility to be built in the parking lot of the former North General Hospital.
- PRIOR AUTHORIZATION (Revised 6/7/13):** Previous work order for \$118,336,989 was approved by the Capital Committee in February 2012 (attached). The previously authorized funds, as of 04/30/13, have been expended in the amounts identified below for the following goods or services: \$9,090,687 has been paid out to Array Architects for all design documents and a portion of construction administration. \$16,323,396 has been paid out to Gilbane/McKissack for preconstruction services, and construction management services. \$50,918,740 has been paid out to Gilbane/McKissack which accounts for approximately 75% of the trade cost values. \$696,744 has been paid out to EDC for its management costs.
- TERMS:** The work order will be executed pursuant to a Memorandum of Understanding (MOU) by and between the Corporation and NYCEDC.
- COST:** Current projected cost of \$132,450,756 via Work Order to NYCEDC, exclusive of land acquisition costs, planning and design services, Value Engineering and CON additional processing fees to the New York State Department of Health. Total budget is \$141,067,220.
- FINANCING:** \$9,839,547 in HEAL NY Phase 19 grant proceeds; \$141,067,220 in New York City General Obligation Bonds.
- SCHEDULE:** Completion: November 2013.

WORK ORDER

ECONOMIC DEVELOPMENT CORPORATION

**HENRY J. CARTER
LONG TERM ACUTE CARE HOSPITAL**

**NEW YORK CITY HEALTH & HOSPITALS CORPORATION
CAPITAL COMMITTEE**

**NEW YORK CITY ECONOMIC
DEVELOPMENT CORPORATION
WORK ORDER APPROVAL**

Date: June 13, 2013

In accordance with a Memorandum of Understanding by and between HHC and the New York City Economic Development Corporation (NYCEDC), the President of HHC respectfully submits for approval by the Capital Committee, the following Work Order to be issued to NYCEDC:

Facility: North General Hospital, also known as "Goldwater North"

Title: Renovation and Construction of New Goldwater North Long Term Acute Care Hospital (LTACH)

Scope: Serving as managing agent, EDC will cause to provide all architectural, engineering design services, pre-construction, construction, construction management and project management services necessary for the renovation of the former North General Hospital building into a new Long Term Acute Care Hospital building (LTACH).

Need: Renovation of the existing North General building into a Long Term Acute Care Hospital (LTACH) addresses targeted initiatives to reduce beds by 216. Decision to proceed with this initiative occurred after preliminary reviews determined that the existing Goldwater Hospital campus required significant modification to meet current regulatory codes and long term care standards. Upgrading to a newer, more modern facility and vacating the Goldwater campus is considered the most cost effective opportunity. The bed reduction initiative is supported by HHC's receipt of a Health Care Affordability and Efficiency Law (HEAL) New York Phase 7 grant which targets rightsizing and restructuring of HHC services.

Estimate of Cost:

| | <i>Previously Approved 2/2012</i> | <i>Proposed Authorization Decrease</i> | <i>New Authorization Level</i> | <i>Budget</i> |
|--|---|--|--|----------------------|
| <i>Planning & Design Services</i> | 7,484,818 | 2,032,538 | 9,517,356 | 9,517,356 |
| <i>Construction</i> | 93,261,516 | (14,032,184) | 79,229,332 | 79,229,332 |
| <i>Construction Management</i> | 19,265,726 | 9,989,996 | 29,255,722 | 29,255,722 |
| <i>Other Costs</i> | 871,562 | (716,305) | 155,257 | 155,257 |
| <i>EDC Fee</i> | 2,900,000 | | 2,900,000 | 2,900,000 |
| <i>Contingency</i> | 4,657,157 | (1,373,412) | 3,283,745 | 3,283,745 |
| <i>Fixed Equipment</i> | 0 | | 0 | 2,316,890 |
| <i>Moveable Equipment</i> | 0 | | 0 | 11,509,364 |
| <i>Telecom Equipment</i> | 0 | | 0 | 3,456,820 |
| <i>Total Project Cost</i> | \$128,440,779 | (\$4,099,367) | \$124,341,412 | \$141,624,486 |
| <i>Land Acquisition</i> | 0 | 0 | 0 | 2,510,453 |
| <i>Planning & Design Services</i> | 0 | 0 | 0 | 712,515 |
| <i>VE Services (City G.O. Bonds)</i> | 0 | 0 | 0 | 231,715 |
| <i>VE Services (HEAL 7)</i> | 0 | 0 | 0 | 160,503 |
| <i>CON Additional Processing Fee</i> | 0 | 0 | 0 | 810,608 |
| <i>Total Project Cost w/CON Fee</i> | \$128,440,779 | (\$4,099,367) | \$124,341,412 | \$153,468,878 |

Funding:

| | | | | |
|-------------------------------------|----------------------|----------------------|----------------------|----------------------|
| <i>HEAL NY Phase 7 *</i> | 6,846,374 | 0 | 6,846,374 | 8,530,000 |
| <i>HEAL NY Phase 19 **</i> | 0 | 0 | 0 | 2,510,453 |
| <i>NYC General Obligation Bonds</i> | 121,594,405 | (\$4,099,367) | 117,495,038 | 136,693,453 |
| <i>Total</i> | \$128,440,779 | (\$4,099,367) | \$124,341,412 | \$146,050,280 |

End Date: November 2013

CON: Full Review

Filed: October 2011

Approval: December 2011

EXECUTIVE SUMMARY

MAJOR MODERNIZATION PROJECT GOLDWATER NORTH LONG TERM ACUTE CARE HOSPITAL BY NEW YORK CITY ECONOMIC DEVELOPMENT CORPORATION

- OVERVIEW:** The President seeks authorization to decrease New York City Economic Development Corporation's (NYCEDC) work order threshold by four million, ninety-nine thousand, three hundred and sixty-seven dollars (-\$4,099,367) to one hundred twenty-four million, three hundred forty-one thousand, four hundred and twelve dollars (\$124,341,412) to continue providing project management services to manage the architectural, engineering design services, pre-construction, construction, construction management services for renovating the existing North General Hospital building into a new 201 bed Long Term Acute Care Hospital building (LTACH).
- NEED:** Renovation of the existing North General building into a Long Term Acute Care Hospital (LTACH) addresses targeted initiatives to reduce beds by 216. Decision to proceed with this initiative occurred after preliminary reviews determined that the existing Goldwater Hospital campus required significant modification to meet current regulatory codes and long term care standards. Upgrading to a newer, more modern facility and vacating the Goldwater campus is considered the most cost effective opportunity. The bed reduction initiative is supported by HHC's receipt of a Health Care Affordability and Efficiency Law (HEAL) New York Phase 7 grant which targets rightsizing and restructuring of HHC services. The new building will be LEED certified.
- SCOPE:** NYCEDC is serving as managing agent and is contracted to provide all architectural and engineering design services, pre-construction, construction, construction management and project management services necessary for the renovation at the former North General Hospital building into a new Long Term Acute Care Hospital (LTACH).
- PRIOR AUTHORIZATION:** Previous work order for \$128,440,779 was approved by the Capital Committee in February 2012 (attached). The previously authorized funds, as of 4/30/13, have been expended in the amounts identified below for the following goods or services: \$7,805,786 has been paid out to Array Architects for all design documents and a portion of construction administration. \$20,161,435 (of which \$2,458,336 was for existing building maintenance and transition planning management) has been paid out to Gilbane/McKissack for preconstruction services including planning, and construction management oversight.. \$45,077,499 has been paid out to Gilbane/McKissack for trade work accounting for approximately 75% of the construction value. \$472,160 has been paid out to EDC for its management costs.
- TERMS:** The work order is to be executed pursuant to an existing Memorandum of Understanding (MOU) by and between the Corporation and NYCEDC.
- COST:** Current projected costs of \$124,341,412 via Work Order to EDC, exclusive of land acquisitions costs, planning and design services, Value Engineering and CON additional processing fees to the New York State Department of Health. Total project budget is \$146,050,280. Decommissioning costs of the Goldwater facility in the amount of \$5,251,000, funded with City General Obligation bonds, are excluded.
- FINANCING:** \$6,846,374 in HEAL NY Phase 7 grant proceeds; \$2,510,453 in HEAL 19 grant proceeds; and \$136,693,453 in New York City General Obligation Bonds.
- SCHEDULE:** Completion: November 2013.

STATUS REPORT

**HENRY J. CARTER SPECIALTY HOSPITAL AND
NURSING FACILITY**

MAJOR MODERNIZATION

**HENRY J. CARTER SPECIALTY HOSPITAL AND NURSING FACILITY
GOLDWATER NORTH PROJECT
PROJECT FACT SHEET**

Location: 1879 Madison Avenue
New York, New York 10035
(On the site of the former North General Hospital)

Description: Construction of a new 164-bed Skilled-Nursing Facility (SNF); Renovation and conversion of existing building (formerly known as North General Hospital) into a 201-bed Long-Term Acute Care Hospital (LTACH). The LTACH beds have been reduced by 80 beds from 281 to 201 beds and the SNF from 276 to 164.

Budget:

| | |
|----------------------|-------------------|
| NYC G.O. (SNF) | \$ 119.0 M |
| NYC G.O. (LTACH) | \$ 144.7 M |
| HEAL NY Phase 19 | \$ 12.3 M |
| HEAL NY Phase 7 | <u>\$ 8.5 M</u> |
| Total Funding | \$ 284.5 M |

| | | |
|-----------------------------|-------|-------------------------------|
| Approved EDC | SNF | \$118,336,989 (February 2012) |
| Work Orders to date: | LTACH | \$128,440,779 (February 2012) |

Managing Agent: New York City Economic Development Corporation (EDC)

Architect: Array Healthcare Facilities Solutions with Geddis Architects

Construction Manager: Gilbane Building Company/ McKissack & McKissack, a joint venture

CON Status: SNF- Approved - January 2012
Long-Term Care- Approved – December 2011

Schedule: LTACH Completion Expected – 11/1/2013
SNF Completion Expected – 11/1/2013

AA/EEO: EDC will satisfy Affirmative Action (AA) and Equal Employment Opportunity (EEO) requirements on behalf of the Corporation. HHC and EDC will provide opportunities for M/WBE firms to comply with NYS Executive Law Article 15-A and NYC Executive Order 50 requirements.

**HENRY J. CARTER SPECIALTY HOSPITAL AND NURSING FACILITY
GOLDWATER NORTH PROJECT
PROJECT STATUS REPORT – May 2013**

The following are key project activities the Corporation has completed to date:

Design: Array Healthcare Solutions, in association with Barbara Geddis Architects, were awarded the design contract. The design is complete.

Construction: Project bidding is substantially complete for both LTACH and SNF with approximately 99% of trade work awarded to date on EDC held contracts. SNF excavation, foundation, superstructure, precast façade, curtain wall, and window installation are complete. The interior MEP riser and horizontal distributions are underway as are the vertical transportation systems and drywall installation has progressed to the lower floors. The interior finish work has begun on the upper floors with painting, ceiling grid and tiles, and flooring installation underway. Interior demolition on the LTACH is complete. LTACH MEP infrastructure, interior wall layout, roofing, and façade restoration is substantially complete. Drywall installation is ongoing and painting and bathroom tile installation has progressed to the lower floors. Punchlist work has begun on the 6th and 7th floors, as interior finish work is substantially complete on those floors. Some of the major fixed medical equipment items are currently being installed by HHC contracted vendors.

Construction Management (CM): Gilbane Building Company/ McKissack & McKissack. This project integrates the CM into the design process, which helps facilitate resolution of construction related issues during the design process, maximizing the effectiveness of the construction management process prior to and during construction.

Other Considerations: HHC has taken possession of the existing building and the site.

AIR CONDITIONING READINESS REPORT

JOHNSON CONTROLS, INC.

2013 FACILITIES AIR CONDITIONING READINESS REPORT
(Status as of March, 2013)

GOOD



| |
|--|
| Cumberland |
| Goldwater |
| Gouverneur |
| Harlem (MLK Pavilion) Metropolitan (Main Hospital Building) |
| Morrisania |
| Jacobi |
| North Central Bronx |
| Queens |

CONDITIONAL

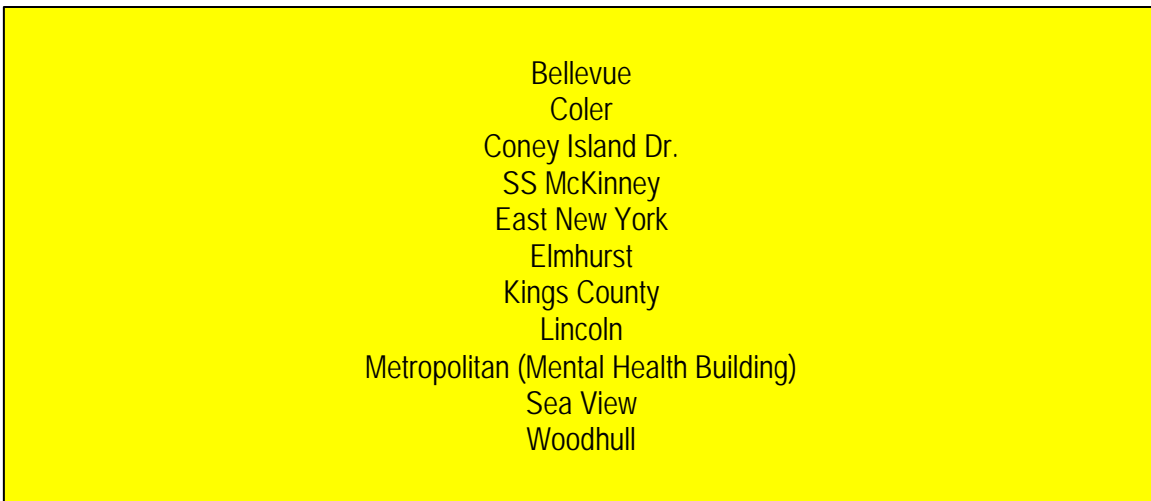

| |
|---------------------------------------|
| Bellevue |
| Coler |
| Coney Island Dr. |
| SS McKinney |
| East New York |
| Elmhurst |
| Kings County |
| Lincoln |
| Metropolitan (Mental Health Building) |
| Sea View |
| Woodhull |

FAIR

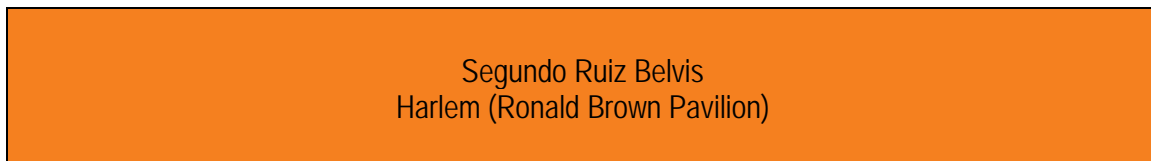

| |
|--------------------------------|
| Segundo Ruiz Belvis |
| Harlem (Ronald Brown Pavilion) |

GREEN (Good)

YELLOW (Conditional)

ORANGE (Fair)

2013 NETWORK FACILITIES AIR CONDITIONING READINESS (Status as of March 31, 2013)

The Corporation has concluded its annual survey of acute care, long term care and diagnostic and treatment facilities to ascertain their state of preparedness to deliver adequate air conditioning and ventilation throughout the 2013 cooling season. The survey focused on facility's ability to maintain required temperature and humidity levels throughout patient care areas, particularly critical care areas required by the State Health Code.

HHC has contracted with Johnson Controls for facilities management services. Johnson Controls has managed and maintained the current cooling systems in accordance with manufacturer's recommendations. See attached facilities list.

Nine sites were rated to be in a "good" state of preparedness to provide air conditioning throughout the 2013 cooling season. These are **Cumberland, Goldwater, Gouverneur, Harlem (MLK Pavilion), Metropolitan (Main Hospital Building), Morrisania, Jacobi, North Central Bronx, and Queens**. Last year's 2012 report listed thirteen facilities with a rating of "good."

Eleven sites were rated "conditional" because of air conditioning system deficiencies that are either now being corrected or that will continue during the 2013 cooling season. These are **Bellevue, Coler, Coney Island, Dr. Susan Smith McKinney, East New York, Elmhurst, Kings County, Lincoln, Metropolitan (Mental Health Building), Sea View and Woodhull**. Last year's 2012 report listed eight facilities as "conditional." Since then, **the New Chiller Plant at Harlem Hospital was completed and the 225 ton chiller serving the Ronald H. Brown Building at Harlem was repaired, and the new chiller and cooling tower at Gouverneur were put into operation.**

Two sites were rated as "fair" because of aged or out of service equipment. Those sites are **Segundo Ruiz Belvis** and the **Harlem Hospital Ronald Brown Pavilion**. Last year's 2012 report listed no facilities as "fair".

Each facility with a conditional rating has a contingency plan in place to respond to system failures which threaten to disrupt air conditioning services.

The Office of Facilities Development will continue to work closely with each facility and provide technical assistance, as needed, to minimize disruption of air conditioning services.

NETWORK: GENERATIONS+ / NORTHERN MANHATTAN HEALTH NETWORK

| FACILITY | READINESS RATING | SYSTEM PROBLEMS DESCRIPTION | AREAS AFFECTED | PLANNED OR ONGOING CORRECTIVE ACTION | REMARKS |
|------------|------------------|---|-------------------------------------|--|---|
| LINCOLN | Conditional | Five cells of cooling tower are aged and require repair. CHW coils on AC 16 and 26 need replacement | Entire Building Pharmacy OR's | The cells are to be upgraded in two stages (of two cells and three cells), which requires \$1.65 million in funding. | Fan motor of cell #4 was replaced last summer due to 20% loss of cooling capacity from motor malfunction. |
| BELVIS | Fair | Equipment is aged | all | Major PM and evaluation | |
| MORRISANIA | Good | n/a | n/a | n/a | |
| HARLEM | Good | New Chiller Plant project was completed. Two new electric centrifugal chillers (1800 tons each) and one 1600 ton steam chiller are ready for operation. | MLK Pavilion | n/a | n/a |
| | Fair | One 225 ton carrier chiller was repaired and is ready to be on-line. One chiller out of service, undergoing evaluation | Ronald H. Brown Pavilion | n/a | n/a waiting assessment report |

NETWORK: NORTH BRONX HEALTH NETWORK

| FACILITY | READINESS RATING | SYSTEMS PROBLEMS DESCRIPTION | AREAS AFFECTED | PLANNED OR ONGOING CORRECTIVE ACTION | REMARKS |
|---------------------|------------------|------------------------------|----------------|--------------------------------------|---------|
| JACOBI | Good | n/a | n/a | n/a | |
| NORTH CENTRAL BRONX | Good | n/a | n/a | n/a | |

Rating of "good" denotes no system problems are expected.

Rating of "conditional" denotes deficiencies that are now being corrected or will continue during the 2013 cooling season.

Rating of "fair" denotes that the equipment is aged or out of service and major preventative maintenance and evaluation is required.

NETWORK: NORTH BROOKLYN HEALTH NETWORK

| FACILITY | READINESS RATING | SYSTEM PROBLEMS DESCRIPTION | AREAS AFFECTED | PLANNED OR ONGOING CORRECTIVE ACTION | REMARKS |
|------------|------------------|---|-----------------|--|--|
| CUMBERLAND | Good | n/a | n/a | n/a | |
| WOODHULL | Conditional | 52 central HVAC fans are in poor working condition. Leakage, stratification and air balance are the primary problems. | Entire hospital | 3 air handlers have been replaced on 7 th floor (Phase I). Design has been completed for upgrade of 3 units on 2 nd floor serving the E.R. (Phase II). Replacement of additional 49 units continues based upon funding availability. | The hospital engineering department will continue to make necessary repairs of HVAC units as needed. |
| | Conditional | Chiller #1, #2 and #3 in Chiller Plant experiencing problems with resistors bank. Resistors burning during start-up | | Johnson Controls is installing analyzers in the Chiller Plant to evaluate the Chillers and power source to identify the cause. | Three of the four Chillers currently operational. |

Rating of "good" denotes no system problems are expected.

Rating of "conditional" denotes deficiencies that are now being corrected or will continue during the 2013 cooling season.

Rating of "fair" denotes that the equipment is aged or out of service and major preventative maintenance and evaluation is required.

NETWORK: NORTH BROOKLYN HEALTH NETWORK

| FACILITY | READINESS RATING | SYSTEM PROBLEMS DESCRIPTION | AREAS AFFECTED | PLANNED OR ONGOING CORRECTIVE ACTION | REMARKS |
|---|------------------|--|-------------------------------------|---|---|
| EAST NEW YORK DIAGNOSTIC AND TREATMENT CENTER | Conditional | AHU-1, located in basement, and AHU, located on roof are in poor condition and need coil/blower retrofit and replacement, respectively | Main Building and Behavioral Health | Project is being scoped out and a specification is being prepared for bid. Project in design. Replacement to begin after cooling season. System functional. | Portable units used in essential areas in event of unlikely failure. |
| Dr. SUSAN SMITH MCKINNEY | Conditional | 1 Electric Chiller not operational due to oil leak | Entire hospital | JCI to come on site to perform an assessment of the issue and a PO will be issued for repairs | Engineering will continue to monitor the performance of both chillers throughout the cooling season |

Rating of "good" denotes no system problems are expected.

Rating of "conditional" denotes deficiencies that are now being corrected or will continue during the 2013 cooling season.

Rating of "fair" denotes that the equipment is aged or out of service and major preventative maintenance and evaluation is required.

| | | | | | |
|-------------------------------------|--------------------|---|------------------------------------|---|------------|
| <p>KINGS COUNTY HOSPITAL CENTER</p> | <p>Conditional</p> | <p>E-building chillers are operational. All AHU are operational except AHU 4: return fans 1 and 2 bearings need replacement.</p> <p>D-building chillers 1 and 2 are operational. Chiller 3 is inoperable and condemned. All AHU are operational; VFD drives on return fan 5, 7, and 8 inoperable and unserviceable.</p> <p>ABC- building compressor units are in good condition. The AHU has broken dampers, insufficient controls, some leaks in the system, and some air cooled condensers matted.</p> <p>R-building chillers and AHU are operational. The electrical vault a/c system needs a new compressor.</p> <p>S-building chillers and air handlers are operational.</p> <p>S.O.B. a/c compressors are operational. The AHU and controls are in poor condition.</p> <p>T-building 5th floor chiller is operational and the auditorium a/c unit is operational. The AHU and control system is in poor condition.</p> <p>The campus wide Mitsubishi split systems are operational.</p> | <p>Entire hospital/Campus wide</p> | <p>E-building: Ordered replacement bearings and will be installed by onsite engineering staff.</p> <p>D-building: Ordered replacement VFD for return fans. Chiller 3 to be replaced/funded by HHC.</p> <p>ABC-building: The engineering staff will continue to monitor the a/c system and make repairs to the AHU; onsite engineering staff will replace the broken dampers.</p> <p>R-building: Engineering staff to replace vault a/c compressor.</p> <p>SOB: Engineering to make repairs as needed to the a/c system. The a/c unit is scheduled to be replaced by HHC.</p> <p>T-building: The engineering staff will continue to monitor and make repairs to the chiller and a/c system as needed.</p> <p>Mitsubishi Split System: Engineering will continue to monitor the split systems and make repairs as needed.</p> | <p>n/a</p> |
|-------------------------------------|--------------------|---|------------------------------------|---|------------|

Rating of "good" denotes no system problems are expected.

Rating of "conditional" denotes deficiencies that are now being corrected or will continue during the 2013 cooling season.

Rating of "fair" denotes that the equipment is aged and major preventative maintenance and evaluation is required.

NETWORK: SOUTH BROOKLYN / STATEN ISLAND HEALTH NETWORK

| FACILITY | READINESS RATING | SYSTEM PROBLEMS DESCRIPTION | AREAS AFFECTED | PLANNED OR ONGOING CORRECTIVE ACTION | REMARKS |
|-----------------------|------------------|---|---|--|---|
| SEA VIEW | Conditional | Replacement of air conditioning mixing boxes will be required, and control of air handlers is not automated. | Robitzek (Patient) Building | One mixing box replaced in-house, with more to be done as needed. The air handler automation project is currently on hold. | No issues anticipated. |
| CONEY ISLAND HOSPITAL | Conditional | Replacement of air handlers, A/C's Absorbers repair and/or replacement of pumps, motors and VFD Chiller repairs Cooling towers replacement | MB 5N14, 5N6, 14 th floor elevator machine room, 9N Hematology, 1N28, 1N48, 1 N Print shop, 7N and 8N (OR), 1 st floor ER, 2N1D, 206 (Pharmacy) , 9N38, Bed Tower and MB 4 north. MB 2 floor auditorium MB Dietary and Nuclear medicine (5N6) | Repairs are ongoing, replacement needed | Constant maintenance and repairs being performed on the listed equipment. |

Rating of "good" denotes no system problems are expected.

Rating of "conditional" denotes deficiencies that are now being corrected or will continue during the 2013 cooling season.

Rating of "fair" denotes that the equipment is aged and major preventative maintenance and evaluation is required.

NETWORK: SOUTH MANHATTAN HEALTH NETWORK

| FACILITY | READINESS RATING | SYSTEM PROBLEMS DESCRIPTION | AREAS AFFECTED | PLANNED OR ONGOING CORRECTIVE ACTION | REMARKS |
|--------------|--|---|--|--|---|
| BELLEVUE | Conditional | <p>A secondary chiller is required to provide cooling and maintain humidity levels during the non-peak season. Air handlers serving the 11th floor operating rooms are in need of replacement</p> <p>One cooling tower on line, one being prepared for use. Future replacement required</p> | <p>Main Building and 11th Floor O.R.s</p> <p>Main Building, E.R. Department, and Ambulatory Care Building</p> | <p>Consultant has completed construction documents to install the secondary chiller.</p> <p>Engineering consultant has been engaged.</p> | <p>Replacement anticipated beginning, before the beginning of the 2014 cooling season.</p> <p>Once study is completed, facility will request capital funding for Cooling Tower upgrade and modernization.</p> |
| METROPOLITAN | <p>Good</p> <p>Conditional</p> <p>Out of service</p> | <p>Chiller plant: Two 1,150 ton chillers are near maximum capacity with additional load added by Mental Health chillers being out of service.</p> <p>Existing absorption chillers are 45 years old and not available for use, putting additional load on main building chiller. The Mental Health building chiller will be air-conditioned via the main hospital chillers.</p> <p>Air conditioning system damaged by Sandy.</p> | <p>Main Hospital</p> <p>Mental Health Building</p> <p>Draper Hall</p> | <p>The need for an additional 3rd centrifugal chiller to serve the Main Hospital and Mental Health Building has been established.</p> | <p>Evaluation of replacement options will be analyzed prior to next cooling season.</p> <p>Draper Hall is a non-patient care building and the future of Draper Hall is not yet finalized.</p> |
| GOUVERNEUR | Good | n/a | n/a | n/a | n/a |

Rating of "good" denotes no system problems are expected.

Rating of "conditional" denotes deficiencies that are now being corrected or will continue during the 2013 cooling season.

Rating of "fair" denotes that the equipment is aged or out of service and major preventative maintenance and evaluation is required.

NETWORK: SOUTH MANHATTAN HEALTH NETWORK (CONTINUED)

| | | | | | |
|-----------|-------------|---|----------|---------------------------------------|--|
| COLER | Conditional | A21 / 22 chiller replacement is required. Two S bldg roof top units damaged by Sandy, replacement TBD | A21 / 22 | Window A/C units have been installed. | Purchase order issued for chiller replacement. |
| GOLDWATER | Good | n/a | n/a | n/a | |

NETWORK: QUEENS HEALTH NETWORK

| FACILITY | READINESS RATING | SYSTEM PROBLEMS DESCRIPTION | AREAS AFFECTED | PLANNED OR ONGOING CORRECTIVE ACTION | REMARKS |
|----------|------------------|---|---|---|---------|
| ELMHURST | Conditional | Cooling coil failure on ACS-D1, currently running on only the top coil. | Nuclear Medicine on the 4 th floor D-wing, Labor and Delivery Recovery room on 5 th floor D-wing. | Failed coil has been isolated and blanked off to provide moderate cooling. New coil has been ordered 5 week lead time for delivery. | |
| | | Histology & Chemistry Labs on 3 rd floor E-wing have multiple A/C unit failures. Difficult to maintain a cool environment during hot days. | Labs on the 3 rd Floor in the E-wing. | Replacement components are being investigated and parts will be ordered to perform the repairs. | |
| | | Data center split units have failed and were undersized to begin with. | Data center in BB-07 | Heat load calculations have been performed and a new unit has been ordered that will handle the current & predicted conditions. | |

Rating of "good" denotes no system problems are expected.

Rating of "conditional" denotes deficiencies that are now being corrected or will continue during the 2013 cooling season.

Rating of "fair" denotes that the equipment is aged or out of service and major preventative maintenance and evaluation is required.

| | | | | | |
|----------|-------------|---|---|---|--|
| ELMHURST | Conditional | Cooling coil failure on AHU serving Microbiology. | Microbiology, 5 th floor E-wing. | Coil is being evaluated for replacement. | |
| | | General preventive maintenance and coil cleaning is needed on a majority of the Air Handling Units and condenser units throughout the Hospital. | Hospital-wide. | Hospital staff will perform cleanings on an as needed basis until a comprehensive program can be developed. | Outside vendor assistance will be necessary. |
| QUEENS | Good | Main building cooling tower is in need of some minor repairs, P.O.'s have already been generated | n/a | Atlantic cooling will be replacing the FRP cylinder before the start of the cooling season. | The hospital engineering department will continue to make all necessary repairs of the HVAC units as needed. All four chillers have been completely serviced in preparation for the 2013 cooling season. |

Rating of "good" denotes no system problems are expected.

Rating of "conditional" denotes deficiencies that are now being corrected or will continue during the 2013 cooling season.

Rating of "fair" denotes that the equipment is aged or out of service and major preventative maintenance and evaluation is required.

PROJECT STATUS REPORTS

Central/North Brooklyn Health Network
Generations+/Northern Manhattan Health Network
Queens Health Network

Network: CENTRAL / NORTH BROOKLYN HEALTH NETWORK

Facility: WOODHULL MEDICAL AND MENTAL HEALTH CENTER

| Project Number | PROJECT TITLE | Project Budget (\$000s) | Paid to Date (\$ 000s) | % Paid to Date | Construction Start | Projected Completion | Forecast/ Actual Completion | Delay (if any) | Comments |
|----------------|---------------------------|-------------------------|------------------------|----------------|--------------------|----------------------|-----------------------------|----------------|--|
| 48201150 | Replace Nurse Call System | 774 | 176 | 23.00% | Dec-11 | May-13 | Jun-13 | (1) | Termination and testing of cabling is completed on all floors. The installation of the interface panels in all closets was completed. Testing of strobe lights, installation of switches in IT closets and certification of the system is pending. Head-end equipment were delivered in April 2013, and is being integrated into the installation. Project is 94 % complete. |

Facility: HARLEM HOSPITAL CENTER

| Project Number | PROJECT TITLE | Project Budget (\$000s) | Paid to Date (\$ 000s) | % Paid to Date | Construction Start | Projected Completion | Forecast/ Actual Completion | Delay (if any) | Comments |
|----------------|----------------------------|-------------------------|------------------------|----------------|--------------------|----------------------|-----------------------------|----------------|---|
| 13200702/03 | Kountz Pavilion Renovation | 13,545 | 10,799 | 80.00% | Mar-08 | Apr-12 | Jul-13 | (15) | Elevator Project substantially complete as of 3-11-2013. Exterior Renovation Project roofing installation delayed due to weather conditions (cold and or wet); projected to be completed by July, 2013. |

Facility: LINCOLN MEDICAL AND MENTAL HEALTH CENTER

| Project Number | PROJECT TITLE | Project Budget (\$000s) | Paid to Date (\$ 000s) | % Paid to Date | Construction Start | Projected Completion | Forecast/ Actual Completion | Delay (if any) | Comments |
|----------------|---------------------------|-------------------------|------------------------|----------------|--------------------|----------------------|-----------------------------|----------------|---|
| 25200301 | Emergency Room Renovation | 28,275 | 20,794 | 74.00% | Apr-07 | Jun-10 | Dec-13 | (42) | Project scheduled for completion by Dec. 2013 |

Facility: ELMHURST HOSPITAL CENTER

| Project Number | PROJECT TITLE | Project Budget (\$000s) | Paid to Date (\$ 000s) | % Paid to Date | Construction Start | Projected Completion | Forecast/ Actual Completion | Delay (if any) | Comments |
|----------------|-----------------------|-------------------------|------------------------|----------------|--------------------|----------------------|-----------------------------|----------------|---|
| 33200801 | Women's Health Center | 13,352 | 6,423 | 48.00% | Sep-11 | Dec-12 | Sep-13 | (9) | Rough plumbing is completed. DOB inspection will be requested. Insullation of ductwork continues. |

Facility: QUEENS HOSPITAL CENTER

| Project Number | PROJECT TITLE | Project Budget (\$000s) | Paid to Date (\$ 000s) | % Paid to Date | Construction Start | Projected Completion | Forecast/ Actual Completion | Delay (if any) | Comments |
|----------------|-------------------------|-------------------------|------------------------|----------------|--------------------|----------------------|-----------------------------|----------------|---|
| 34200970 | Modernization Phase III | 21,995 | 17,483 | 80.00% | Apr-09 | Dec-11 | Apr-13 | (16) | DOH inspection was conducted on April 17, 2013. All DOH deficiencies have been corrected. Project will be removed after this reporting cycle. |